



Rolling

at the speed of life



Rollen & Räder
Castors & Wheels



Inhalt

Index

Unternehmen Company

Symbole
Symbols

Seite
Page

3

Qualität
Quality

5

Historie
History

6

Niederlassungen
Subsidiaries

8

Unternehmen & Marken
Companies & Brands

9

Produkte Products

Möbelrollen
Furniture castors

Seite
Page

10

Apparaterollen
Apparatus castors

20

Medizinisch-Techn. Rollen
Medical equipment castors

70

Transportgeräterollen
Transport appliance castors

98

Edelstahlrollen
Stainless steel castors

118

Schwerlastrollen
Heavy duty castors

122

Räder
Wheels

130

Zubehör
Accessories

148

Rollentechnik und Anforderungen Castor technology and requirements

Seite

Page

Rollentypen
Castor types

156

Räder
Wheels

158

Radlagerarten
Bearing Types

160

Gehäusevarianten
Types of housings

162

Feststellervarianten
Types of brakes

164

Befestigungen
Attachments

165

Manövrierbarkeit
Manoeuvrability

166

Chemische Beständigkeit
Chemical resistance

167

Anfahr- und Rollwiderstände
Resistance to starting and rolling

168

Tragfähigkeit
Load rating

169

Umgebungsverhältnisse
Environmental conditions

170

**Bestellsystem für
Colson Produkte**
Reference system for
Colson products































172

Produkthaftung /AGBs
Product liability /
general sales conditions

176

Symbole

Symbols

	Raddurchmesser wheel diameter		2 Kugellager 2 ball bearings
	Radbreite wheel width		Tragfähigkeit load capacity
	Nabenlänge hub width		Gewicht weight
	Achsllochbohrung bore diameter		Lenkrolle swivel castor
	Hohlachse bushing		Bockrolle fixed castor
	Befestigungsplatte Außenmaße top plate dimensions		mit Radfeststeller wheel locking brake
	Lochabstand bolt hole spacing		mit Totalfeststeller nachlaufend total brake mounted behind
	Schraubloch Durchmesser fixing bolt diameter		mit Totalfeststeller vorlaufend total brake mounted in front
	Rückenloch single bolt hole		mit Zentralfeststeller central brake
	Ausladung offset		mit Richtungsfeststeller directional brake
	Bauhöhe overall height		Platte plate
	Schwenkradius brake swivel radius		Gewindestift threaded stem
	Gleitlager plain bearing		Spreizhülse expanding socket
	Rollenlager roller bearing		Zapfen fixing stem
	1 Zentralkugellager 1 central ball bearing		Rohreinsteckhülsenstift nylon socket stem

Rollenherstellung auf höchstem Niveau.

Castor manufacture
of the highest quality.



DESIGNPREIS
NOMINIERT



reddot design award
winner

Wenn Erfahrung das beste Zertifikat für Sie ist. Dann ist es Colson.

If experience is the best certificate for you – then it's Colson.

Alle sprechen von Qualität – von der bestmöglichen Funktion, der langen Lebensdauer und der größtmöglichen Sicherheit ihrer Produkte. Schön und gut. Qualität entsteht jedoch nicht von heute auf morgen. Sie muss erst wachsen. Aus Tradition und Erfahrung. Als ältester Hersteller von Rädern und Rollen in Europa bringen wir beides in Reinkultur mit. Die Qualität unserer Produkte ist somit seit Generationen überliefert. Sie folgt einem Denken, das sich an den wachsenden Ansprüchen der Kunden innerhalb einer immer mobiler und rasanter werdenden Welt orientiert.

Und obwohl wir für unsere buchstäbliche Qualität bekannt sind, steht sie auch auf dem Papier. Unser Qualitätsmanagement wurde auch durch die DQS-Zertifizierungsgemeinschaft anerkannt. Alle fertigungstechnischen und organisatorischen Abläufe entsprechen damit den DIN EN ISO 9001-Anforderungen.

Unsere Erfahrung hingegen ist für uns das wertvollste Zertifikat. Sie profitieren davon. In unserer täglichen Zusammenarbeit. Und durch jede einzelne Rollentype, die nach unzähligen Tests und Prüfungen unser Haus verlässt, um an ihren Produkten die einzigartige Colson-Qualität zum Tragen zu bringen.

Everyone talks about quality – about the best possible operation, long product life and the greatest possible safety of their products. All that is fine, but quality isn't achieved in a day, it has to grow from tradition and experience. As the oldest manufacturer of wheels and castors in Europe, it's our heritage. It results from a way of thinking that is oriented to the growing demands of customers in a world that is rapidly growing in pace and mobility.

And although we are known for our literal quality, now this is also on paper. Our Total Quality Management has also been recognized by the DQS certification organization. All technical and organizational production steps thus meet the DIN/ISO EN 9001 standards requirements.

Our experience, on the other hand, cannot be bought. For us it is the most valuable certificate. You will benefit from it, in our daily cooperation, and through our products which bring the unique Colson quality into action on your equipment.



Besuchen Sie uns online.
Visit us online.

www.colson-rollen.com



Historie History



Über 100 Jahre Erfahrung

Qualität und Dienstleistung haben bei RHOMBUS Rollen eine lange Tradition. Das Unternehmen ist der älteste industrielle Hersteller von Rädern und Rollen in Europa. 1899 in Burg an der Wupper gegründet, begann die Albert Schulte Söhne GmbH & Co. zunächst mit der Produktion von Rollen und Rädern für Klaviere. Unter dem Markennamen „RHOMBUS“ bot das Unternehmen bereits Mitte der dreißiger Jahre des vergangenen Jahrhunderts ein breites Spektrum an Rollen für verschiedenste Einsatzbereiche. In den fünfziger Jahren avancierte der Hersteller aus dem Bergischen Land zu einem der führenden der Branche. 1994 benannte sich das Unternehmen nach seinem Markennamen und firmierte seither unter RHOMBUS Rollen.

Erfolg durch starke Partnerschaft

Darüberhinaus gehört RHOMBUS Rollen seit April 2009 zur Colson Group – dem weltweit führenden Hersteller von Rädern und Rollen. Die Colson Group besteht aus einer Vielzahl von unabhängigen Firmen der Rollenbranche, die weltweit vertreten sind und somit ein besonders großes Produktsortiment für nahezu jeglichen Anwendungsbereich anbieten können.

Neben der RHOMBUS Rollen Holding-GmbH gehört seit Anfang 2020 auch die AS Rollen GmbH, die ihren Sitz ebenfalls in Hückeswagen hat, zur international agierenden Unternehmensgruppe COLSON. Um die Synergieeffekte bestmöglich zu nutzen und gemeinsam auf dem deutschen Markt zu expandieren, wurde entschieden die beiden Unternehmen am Standort von RHOMBUS zusammenzulegen und nun gemeinsam unter dem neuen Unternehmensnamen *Colson Rollen GmbH* zu firmieren.

Dem Grundsatz „Leadership through Partnership“ folgend wird die ständige Weiterentwicklung von Qualität, Service und Kundenbetreuung sowie eine faire Kooperation mit Kunden, Lieferanten und Mitarbeitern angestrebt, sodass dies der für uns folgerichtige Schritt in Richtung Zukunft ist.

Gemäß unserem Slogan „ROLLING AT THE SPEED OF LIFE“ möchten wir allen Ansprüchen des Lebens gerecht werden und Ihnen als kompetenter Partner für den Bezug von qualitativ hochwertigen Rollen & Rädern zur Seite stehen!

Over 100 years' experience

Quality and service have a long tradition at RHOMBUS Rollen. The firm is the oldest industrial manufacturer of wheels and castors in Europe. Founded in 1899 in Burg an der Wupper, Albert Schulte Söhne GmbH & Co. first started with the production of castors and wheels for pianos. Under the brand name „RHOMBUS“, the firm was already supplying a wide range of castors for various areas of application in the mid-thirties of the last century. In the fifties, the manufacturer emerged from the „Bergisches Land“ to become one of the leaders in the sector. In 1994, the firm took the name of its brand and has since operated as RHOMBUS Rollen.

Success through strong partnership

Since April 2009, RHOMBUS has joined the Colson Group, the premier manufacturer of castors and wheels in the world. The Colson Group is made up of a large number of independent castor companies located around the world and can offer a huge product portfolio for nearly every application area.

In addition to RHOMBUS Rollen Holding-GmbH, which has been a successful partner since 2009, AS Rollen GmbH has also been part of the international COLSON group of companies since the beginning of 2020. In order to make the best possible use of the synergy effects and to expand together on the German market, the two companies have now been merged at the RHOMBUS site with the new company name *Colson Rollen GmbH*.

According to the principle „Leadership through Partnership“, we are working for a continuous further development of quality, service and customer care and fair cooperation with customers, suppliers and workers. Therefore it was the right step towards the future!

True to our slogan “ROLLING AT THE SPEED OF LIFE” we want to meet all requirements of life and be your competent partner for the purchase of high quality castors & wheels!

a company of



Niederlassungen in Europa

Subsidiaries in Europe

Deutschland 
Germany

Colson Rollen GmbH
Industriestraße 8
42499 Hückeswagen
Tel. +49 (0)2192 9368-0
Fax +49 (0)2192 9368-477
info@colson-rollen.com
www.colson-rollen.com

Frankreich 
France

COLSON S.A.S
424 Av. de la Couronne
78681 Epône Cédex
Tel. +33 (0)1 30 95 55 45
Fax +33 (0)1 30 95 21 60
info@rhombus.fr
www.rhombus.fr

Großbritannien 
Great Britain

Colson UK Limited
Bagnall Street, Hill Top
West Bromwich B70 0TS
Tel. +44 (0)121 556 7221
Fax +44 (0)121 502 2658
info@colson-castors.co.uk
www.colson-castors.co.uk

Polen 
Poland

Colson Europe B.V. Sp. z. o. o.
ul. Fabianowska 101
62-052 Komorniki
Tel. +48 (0)61 8667 012
biuro@colson.pl
www.colson.pl

Niederlande 
Netherlands

Colson Europe B.V.
Generatorstraat 11
3903 LH Veenendaal
Tel. +31 (0)318 53 66 11
Fax +31 (0)318 52 68 76
info@colson-europe.com
www.colson-europe.com

Italien 
Italy

Colson Italia srl
Via Ancona 15bis
60035 Jesi (AN)
Tel. +39 (0)338 3641389
Fax +39 (0)0731 226631
m.ciranna@colson.it
www.colson.it

Finland 
Finland

Oy Mannerin Konepaja Ab
P.O. Box 3 (Pitkätatu 17)
10901 Hanko
Tel. +358 (0)19 222001
manner@manner.fi
www.manner.fi

Weitere Niederlassungen finden Sie unter
www.colson-rollen.com

Further branches can be found at
www.colson-castors.de



Weltweit Nr.1
worldwide no.1

Unternehmen & Marken

Companies & Brands



Möbelrollen Furniture Castors

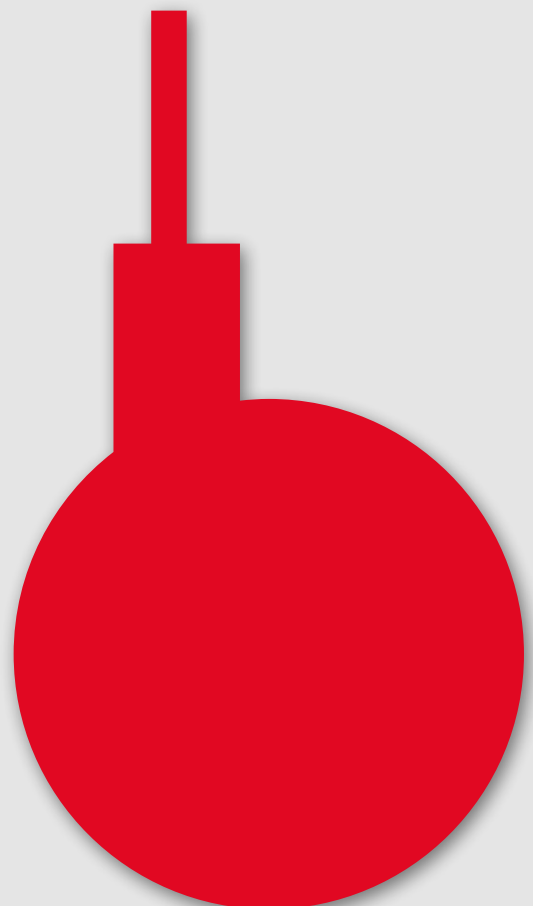

119 Lenkrolle / Swivel castor

Möbelrollen
Furniture castors

Apparaterollen
Apparatus castors

Medizinisch-Technische Rollen
Medical equipment castors

Transportgeräterollen
Transport appliance castors

Edelstahlrollen
Stainless steel castors

Schwerlastrollen
Heavy duty castors

Bäckerrollen
Bakery castors

Räder
Wheels

Zubehör
Accessories



119 050 R	50	110,3	50	



119 050 L (119 810 6767)	50	110,3	50	

Technische Beschreibung

- Kugel-Lenkrolle rechts- oder linksgebogen (L/R)
- Gewindebüchse M 14x1,5x44 mm, 2 Muttern, Gummi-Dichtungsring
- Maß Oberkante Kugel / obere Mutter 65 mm
- Stahldraht-Konstruktion mit schwarzem Gummikugelrad (Shore A 70)

Technical description

- ball-swivel castor right or left (R/L)
- steel wire construction with black rubber spherical wheel (Shore A 70)
- threaded stem M 14x1,5x44 mm, 2 nuts, rubber sealing ring
- measurement top edge ball bearing upper nut 65 mm

176a Bockrolle / Fixed castor

177a Lenkrolle / Swivel castor



176a 33C050b ZPS	50	18	155	60x50	5,5	22,5x38,2	40	



177a 33C050b ZPS	50	18	155	24	60x50	5,5	22,5x38,2	40	

Technische Beschreibung

- Stahlblechgehäuse verzinkt-passiviert
- 90 Grad schwenkbar
- Anschraubplatte demontierbar
- federnd mit belastungsabhängiger Feststellwirkung
- Federweg max. 22 mm, Federdruck 17 kg

Radserie 33Cb

- Vollgummireifen blaugrau (Shore A 80)
- Kunststoff-Radkörper grau
- Metall-Fadenschutz verzinkt-passiviert (ab Ø 75 mm)
- Flanschlager

Technical description

- metal housing
- zinc passivated
- with load related locking effect
- screw-on plate can be removed
- turned through 90°
- total spring distance max. 22 mm,
- total spring pressure 17 kg

Wheel series 33Cb

- solid rubber tyre blue-grey (Shore A 80)
- plastic wheel centre grey
- metal thread guard zinc-passivated (from Ø 75 mm)
- flange bearing

- 197b** Drucklager / Plate ball bearing
- 197d** Drucklager / Plate ball bearing
- 198** Drucklager / Plate ball bearing

Möbelrollen
Furniture castors



197B	19,5	95x70	6,5	75x45	280	

Apparaterollen
Apparatus castors



197D	10,5	57x57	10,5	43x43	50	

Medizinisch-Technische Rollen
Medical equipment castors



198ZPI	19	115x85	9	80x55/60	250	
198ZPK	26	138x109	11	105x75/80	600	

Transportgeräterollen
Transport appliance castors

Edelstahlrollen
Stainless steel castors

Schwerlastrollen
Heavy duty castors

Bäckerrollen
Bakery castors

Räder
Wheels

Zubehör
Accessories

Technische Beschreibung

- Doppelplatten-Drucklager
- einreihiger Kugellauf
- verzinkt-passiviert

Technical description

- double plate ball bearing
- single-row ball race
- zinc-passivated

153a Bockrolle / Fixed castor

156a Bockrolle / Fixed castor

164a Bockrolle / Fixed castor



153a 00G025z ZPS	25	14	27	50x20	4,5	35,5	15	
153a 00G030z ZPS	30	15	33,5	45x20	5,5	35,5	15	
153a 00G035z ZPS	35	18	39	50x25	5,5	40	25	
153a 00G040z ZPS	40	18	46,5	67x26	6,5	54	30	
153a 00G045z ZPS	45	18	49	67x26	6,5	54	35	
153a 00G050z ZPS	50	19	51,5	67x26	6,5	54	40	



153a 33G050b ZPS	50	18	51,5	67x26	6,5	54	40	



156a 00G016g ZPS	16	19	19,5	42x23	4,3	28,5	20	



164a 00G016g ZPS	16	19	20	42x23	4,3	20	20	

Technische Beschreibung

- Stahlblechgehäuse
- verzinkt-passiviert

Radserie 00Gz

- Polypropylen schwarz
- Gleitlager

Radserie 33Gb

- Vollgummireifen blaugrau (Shore A 80)
- Kunststoff-Radkörper schwarz
- Gleitlager

Radserie 00Gg

- Polyamid grau
- Gleitlager

Technical description

- sheet steel housing
- zinc passivated

Wheel series 00Gz

- polypropylene black
- plain bearing

Wheel series 33Gb

- solid rubber tyre blue-grey (Shore A 80)
- plastic wheel centre grey
- plain bearing

Wheel series 00Gg

- polyamide grey
- plain bearing

287a Lenkrolle / Swivel castor

287b Lenkrolle mit Radfeststeller / Swivel castor with wheel locking brake

Möbelrollen
Furniture castors

Apparaterollen
Apparatus castors

Medizinisch-Technische Rollen
Medical equipment castors

Transportgeräterollen
Transport appliance castors

Edelstahlrollen
Stainless steel castors

Schwerlastrollen
Heavy duty castors

Bäckerrollen
Bakery castors

Räder
Wheels

Zubehör
Accessories



287a 00G050x KGB1	50	2x11	56	17	M08x15	40	•				
287a 00G075x KGC	75	2x13	81	24	M10x25	60	•				
287a 00G100x KGC	100	2x16	107	37	M10x25	70	•				
287a 00G125x KGC	125	2x20	135	50	M10x25	80	•				
287b 00G050x KGB1	50	2x11	56	17	M08x15	40	•				
287b 00G075x KGC	75	2x13	81	24	M10x25	60	•				
287b 00G100x KGC	100	2x16	107	37	M10x25	70	•				
287b 00G125x KGC	125	2x20	135	50	M10x25	80	•				
287a 00G050x KPS	50	2x11	60	17	38x38	5	25x25	40	•		
287a 00G075x KPS	75	2x13	87	24	38x38	5	25x25	60	•		
287a 00G100x KPS	100	2x16	107	37	65x55	8	41x51	70	•		
287a 00G125x KPS	125	2x20	135	50	65x55	8	41x51	80	•		
287b 00G050x KPS	50	2x11	60	17	38x38	5	25x25	40	•		
287b 00G075x KPS	75	2x13	87	24	38x38	5	25x25	60	•		
287b 00G100x KPS	100	2x16	107	37	65x55	8	41x51	70	•		
287b 00G125x KPS	125	2x20	135	50	65x55	8	41x51	80	•		

• Artikel auf Anfrage / product on request

Technische Beschreibung

- Gehäuse und Rad aus Polyamid (PA)
- Befestigungen verzinkt
- harte Lauffläche (für weiche Böden)

Radserie 00Gx

- Polyamid schwarz
- Gleitlager

Technical description

- housing and wheel made of polyamide (PA)
- attachments zinc-plated
- hard running surface (for soft floors)

Wheel series 00Gx

- polyamide black
- plain bearing

287a Lenkrolle / Swivel castor

287b Lenkrolle mit Radfeststeller / Swivel castor with wheel locking brake



287a 00G050x KS02	50	2x11	56	17	11x20	40	•
287a 00G075x KS02	75	2x13	81	24	11x20	60	•
287a 00G100x KS02	100	2x16	107	37	11x20	70	•
287a 00G125x KS03	125	2x20	135	50	11x30	80	•
287b 00G050x KS02	50	2x11	56	17	11x20	40	•
287b 00G075x KS02	75	2x13	81	24	11x20	60	•
287b 00G100x KS02	100	2x16	107	37	11x20	70	•
287b 00G125x KS03	125	2x20	135	50	11x30	80	•

• Artikel auf Anfrage / product on request

vGehäuse und Rad aus Polyamid (PA)

- Befestigungen verzinkt
- harte Lauffläche (für weiche Böden)

Radserie 00Gx

- Polyamid schwarz
- Gleitlager

Technical description

- housing and wheel made of polyamide (PA)
- attachments zinc-plated
- hard running surface (for soft floors)

Wheel series 00Gx

- polyamide black
- plain bearing

288a Lenkrolle / Swivel castor

288b Lenkrolle mit Radfeststeller / Swivel castor with wheel locking brake

Möbelrollen
Furniture castors

Apparaterollen
Apparatus castors

Medizinisch-Technische Rollen
Medical equipment castors

Transportgeräterollen
Transport appliance castors

Edelstahlrollen
Stainless steel castors

Schwerlastrollen
Heavy duty castors

Bäckerrollen
Bakery castors

Räder
Wheels

Zubehör
Accessories



	288a 34G050v KGB1	50	2x11	56	17	M08x15				40	•
	288a 34G075v KGC	75	2x13	81	24	M10x25				50	•
	288a 34G100v KGC	100	2x16	107	37	M10x25				60	•
	288a 34G125v KGC	125	2x20	135	50	M10x25				80	•
	288b 34G050v KGB1	50	2x11	56	17	M08x15				40	•
	288b 34G075v KGC	75	2x13	81	24	M10x25				50	•
	288b 34G100v KGC	100	2x16	107	37	M10x25				60	•
	288b 34G125v KGC	125	2x20	135	50	M10x25				80	•
	288a 34G050v KPS1	50	2x11	60	17	38x38	5	25x25		40	•
	288a 34G075v KPS	75	2x13	87	24	38x38	5	25x25		50	•
	288a 34G100v KPS	100	2x16	107	37	65x55	8	41x51		60	•
	288a 34G125v KPS	125	2x20	135	50	65x55	8	41x51		80	•
	288b 34G050v KPS1	50	2x11	60	17	38x38	5	25x25		40	•
	288b 34G075v KPS	75	2x13	87	24	38x38	5	25x25		50	•
	288b 34G100v KPS	100	2x16	107	37	65x55	8	41x51		60	•
	288b 34G125v KPS	125	2x20	135	50	65x55	8	41x51		80	•

• Artikel auf Anfrage / product on request

Technische Beschreibung

- Gehäuse und Rad aus Polyamid (PA-RAL 7035)
- Befestigungen verzinkt
- auch lieferbar mit Einschlagbefestigung KS02 (11x20)

Radserie 34Gv

- Radbandage aus Polyurethan (PU-RAL 7015)
- weiche Lauffläche (für harte Böden)

Technical description

- housing and wheel made of polyamide (PA-RAL 7035)
- attachments zinc-plated
- also available with stem KS02 (11x20)

Wheel series 34Gv

- wheel bandage of polyurethane (PU-RAL 7015)
- soft running surface (for hard floors)

**Sie haben spezielle
Anforderungen?
Sprechen Sie uns an.
Wir entwickeln gemeinsam
mit Ihnen eine Lösung.**
You have special requests?
Contact us.
We develop a solution
together with you.

**Ihr
Lösungs-
Partner**
Your
Solutions-
Partner

Apparaterollen

Apparatus castors

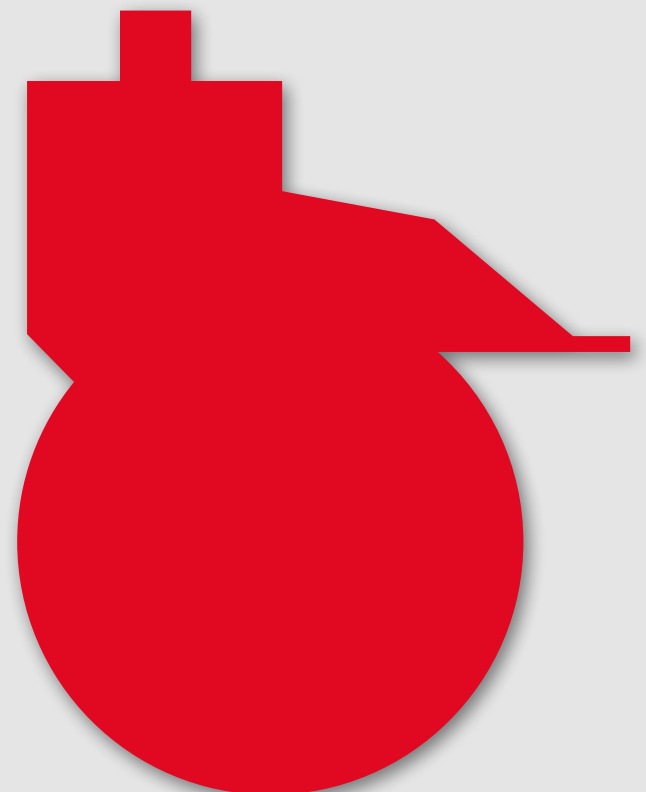

228a Lenkrolle / Swivel castor

316a Lenkrolle / Swivel castor



228a 00G025z ZPS	25	14	39	18	47x47	6,5	35x35	15	
228a 00G030z ZPS	30	15	42	18	47x47	6,5	35x35	15	
228a 00G035z ZPS	35	18	48	18	47x47	6,5	35x35	25	
228a 00G040z ZPS	40	18	57	23	57x57	6,5	43x43	35	
228a 00G045z ZPS	45	18	60	23	57x57	6,5	43x43	35	
228a 00G050z ZPS	50	19	62	23	57x57	6,5	43x43	45	



316a 00G030z ZLB	30	18	46	15,5		8,2		15	
316a 00G038z ZLC	38	17	59	17,5		10,2		20	

Technische Beschreibung

- Stahlblechgehäuse
- verzinkt-passiviert
- einreihiger Kugellauf im Gabelkopf

Radserie 00Gz

- Polypropylen schwarz
- Gleitlager

Technical description

- metal housing
- single-row ball race in fork head
- zinc passivated

Wheel series 00Gz

- polypropylene black
- plain bearing

340a Lenkrolle / Swivel castor

340h Lenkrolle mit Totalfeststeller nachlaufend / Swivel castor with total brake mounted behind

345a Bockrolle / Fixed castor



340a 29G050r ZPC-5		50	20	69,5	24	60X60	6,3	43x43	40	•
340a 29G075r ZPC-5		75	25	100	28	60X60	6,3	43x43	60	•
340a 29G100r ZPC-5		100	27	134	37	76x76	8,5	55x55	90	•
340a 29G125r ZPC-5		125	27	157	45	76x76	8,5	55x55	120	•
340h 29G050r ZPC-5		50	20	69,5	24	60X60	6,3	43x43	40	•
340h 29G075r ZPC-5		75	25	100	28	60X60	6,3	43x43	60	•
340h 29G100r ZPC-5		100	27	134	37	76x76	8,5	55x55	90	•
340h 29G125r ZPC-5		125	27	157	45	76x76	8,5	55x55	120	•
345a 29G050r ZPC-5		50	20	69,5		60X60	6,3	43x43	40	•
345a 29G075r ZPC-5		75	25	100		60X60	6,3	43x43	60	•
345a 29G100r ZPC-5		100	27	134		76x76	8,5	55x55	90	•
345a 29G125r ZPC-5		125	27	157		76x76	8,5	55x55	120	•

• Artikel auf Anfrage / product on request

Technische Beschreibung

- Stahlblechgehäuse
- Schwenklager mit zweireihigem Kugellauf
- verzinkt-passiviert

Radserie 29Gr

- thermoplastische Elastomer-Bandage (TPE), eisengrau RAL 7011 (Shore A 80)
- Kunststoff-Radkörper silbergrau RAL 7001 ohne Fadenschutz
- Gleitlager
- Kontaktverfärbung auf unversiegelten Böden möglich!

Technical description

- sheet steel metal housing
- swivel bearing with double ball race
- zinc passivated

Wheel series 29Gr

- thermoplastic elastomer tyre (TPE) iron grey RAL 7011 (Shore A 80)
- plastic wheel centre silver grey RAL7001
- without thread guard
- plain bearing
- Contact discoloration on unsealed grounds possible!

340a Lenkrolle / Swivel castor

340h Lenkrolle mit Totalfeststeller nachlaufend / Swivel castor with total brake mounted behind



340a 29G050r ZLC-5	50	20	68	24	10,5	40	•
340a 29G075r ZLC-5	75	25	98	28	10,5	60	•
340a 29G100r ZLC-5	100	27	131,5	37	10,5	90	•
340a 29G125r ZLC-5	125	27	154,5	45	10,5	120	•
340h 29G050r ZLC-5	50	20	68	24	10,5	40	•
340h 29G075r ZLC-5	75	25	98	28	10,5	60	•
340h 29G100r ZLC-5	100	27	131,5	37	10,5	90	•
340h 29G125r ZLC-5	125	27	154,5	45	10,5	120	•

• Artikel auf Anfrage / product on request

Technische Beschreibung

- Stahlblechgehäuse
- Schwenklager mit zweireihigem Kugellager
- verzinkt-passiviert

Radserie 29Gr

- thermoplastische Elastomer-Bandage (TPE), eisengrau RAL 7011 (Shore A 80)
- Kunststoff-Radkörper silbergrau RAL 7001 ohne Fadenschutz
- Gleitlager
- Kontaktverfärbung auf unversiegelten Böden möglich!

Technical description

- sheet steel metal housing
- swivel bearing with double ball race
- zinc passivated

Wheel series 29Gr

- thermoplastic elastomer tyre (TPE) iron grey RAL 7011 (Shore A 80)
- plastic wheel centre silver grey RAL7001
- without thread guard
- plain bearing
- Contact discoloration on unsealed grounds possible!

Möbelrollen
Furniture castors

Apparaterollen
Apparatus castors

Medizinisch-Technische Rollen
Medical equipment castors

Transportgeräterollen
Transport appliance castors

Edelstahlrollen
Stainless steel castors

Schwerlastrollen
Heavy duty castors

Bäckerrollen
Bakery castors

Räder
Wheels

Zubehör
Accessories

340a Lenkrolle / Swivel castor

340b Lenkrolle mit Radfeststeller / Swivel castor with wheel locking brake

341h Lenkrolle mit Totalfeststeller nachlaufend / Swivel castor with total brake mounted behind

345a Bockrolle / Fixed castor



340a 33G050b ZPB	50	18	70	24	54x54	6,3	40x40	40	
341a 33G075b ZPC	75	24	103	37	60x60	6,3	47x47/37x37	50	
341a 33G100b ZPC	100	24	124	28	60x60	6,3	47x47/37x37	60	



340b 33G050b ZPB	50	18	70	24	54x54	6,3	40x40	40	



341h 33G075b ZPC	75	24	103	37	60x60	6,3	47x47/37x37	50	
341h 33G100b ZPC	100	24	124	28	60x60	6,3	47x47/37x37	60	



345a 33G050b ZPB	50	18	70	54x54	6,3	40x40	40		
346a 33G075b ZPC	75	24	103	60x60	6,3	47x47/37x37	50		
346a 33G100b ZPC	100	24	124	60x60	6,3	47x47/37x37	60		

Technische Beschreibung

- Stahlblechgehäuse
- Schwenklager mit zweireihigem Kugellauf
- verzinkt-passiviert

Radserie 33Gb

- Vollgummireifen blaugrau (Shore A 80)
- Kunststoff-Radkörper schwarz
- Gleitlager

Technical description

- sheet steel metal housing
- swivel bearing with double ball race
- zinc passivated

Wheel series 33Gb

- solid rubber tyre blue-grey (Shore A 80)
- plastic wheel centre grey
- plain bearing

340a Lenkrolle / Swivel castor

340b Lenkrolle mit Radfeststeller / Swivel castor with wheel locking brake

341h Lenkrolle mit Totalfeststeller nachlaufend / Swivel castor with total brake mounted behind

Möbelrollen
Furniture castors

Apparaterollen
Apparatus castors

Medizinisch-Technische Rollen
Medical equipment castors

Transportgeräterollen
Transport appliance castors

Edelstahlrollen
Stainless steel castors

Schwerlastrollen
Heavy duty castors

Bäckerrollen
Bakery castors

Räder
Wheels

Zubehör
Accessories



340a 33G050b ZLC	50	18	67	24	10,2	40	
341a 33G075b ZLC	75	24	100	37	10,2	50	
341a 33G100b ZLC	100	24	121	28	10,2	60	



340b 33G050b ZLC	50	18	67	24	10,2	40	



341h 33G075b ZLC	75	24	100	37	10,2	50	
341h 33G100b ZLC	100	24	121	28	10,2	60	

Technische Beschreibung

- Stahlblechgehäuse
- Schwenklager mit zweireihigem Kugellager
- verzinkt-passiviert

Radserie 33Gb

- Vollgummireifen blaugrau (Shore A 80)
- Kunststoff-Radkörper schwarz
- Gleitlager

Technical description

- sheet steel metal housing
- swivel bearing with double ball race
- zinc passivated

Wheel series 33Gb

- solid rubber tyre blue-grey (Shore A 80)
- plastic wheel centre grey
- plain bearing

340a Lenkrolle / Swivel castor

340b Lenkrolle mit Radfeststeller / Swivel castor with wheel locking brake

341h Lenkrolle mit Totalfeststeller nachlaufend / Swivel castor with total brake mounted behind



340a 33G050b ZGC	50	18	70	24	M10x25	40	
341a 33G075b ZGC	75	24	103	37	M10x25	50	
341a 33G100b ZGC	100	24	124	28	M10x25	60	



340b 33G050b ZGC	50	18	70	24	M10x25	40	



341h 33G075b ZGC	75	24	103	37	M10x25	50	
341h 33G100b ZGC	100	24	124	28	M10x25	60	

Technische Beschreibung

- Stahlblechgehäuse
- Schwenklager mit zweireihigem Kugellauf
- verzinkt-passiviert

Radserie 33Gb

- Vollgummireifen blaugrau (Shore A 80)
- Kunststoff-Radkörper schwarz
- Gleitlager

Technical description

- sheet steel metal housing
- swivel bearing with double ball race
- zinc passivated

Wheel series 33Gb

- solid rubber tyre blue-grey (Shore A 80)
- plastic wheel centre grey
- plain bearing

340a Lenkrolle / Swivel castor

340b Lenkrolle mit Radfeststeller / Swivel castor with wheel locking brake

341h Lenkrolle mit Totalfeststeller nachlaufend / Swivel castor with total brake mounted behind

Möbelrollen
Furniture castors
Apparaterollen
Apparatus castors
Medizinisch-Technische Rollen
Medical equipment castors
Transportgeräterollen
Transport appliance castors
Edelstahlrollen
Stainless steel castors
Schwerlastrollen
Heavy duty castors
Bäckerrollen
Bakery castors
Räder
Wheels
Zubehör
Accessories



340a 33G050b ZR	50	18	70	24	40	
341a 33G075b ZR	75	24	103	37	50	
341a 33G100b ZR	100	24	124	28	60	



340b 33G050b ZR	50	18	70	24	40	



341h 33G075b ZR	75	24	103	37	50	
341h 33G100b ZR	100	24	124	28	60	

Technische Beschreibung

- Stahlblechgehäuse
- Schwenklager mit zweireihigem Kugellauf
- verzinkt-passiviert
- Befestigung siehe Kapitel »Zubehör«

Radserie 33Gb

- Vollgummireifen blaugrau (Shore A 80)
- Kunststoff-Radkörper schwarz
- Gleitlager

Technical description

- sheet steel metal housing
- swivel bearing with double ball race
- zinc passivated
- attachment see chapter »Accessories«

Wheel series 33Gb

- solid rubber tyre blue-grey (Shore A 80)
- plastic wheel centre grey
- plain bearing

341a Lenkrolle / Swivel castor

341h Lenkrolle mit Totalfeststeller nachlaufend / Swivel castor with total brake mounted behind

346a Bockrolle / Fixed castor



341a 30C100b ZPC	100	23	124	28	60x60	6,3	47x47/37x37	65	



341h 30C100b ZPC	100	23	124	28	60x60	6,3	47x47/37x37	65	



346a 30C100b ZPC	100	23	124		60x60	6,3	47x47/37x37	65	

Technische Beschreibung

- Stahlblechgehäuse
- verzinkt-passiviert
- Schwenklager mit zweireihigem Kugellauf

Radserie 30Cb

- Vollgummireifen blaugrau (Shore A 80)
- Metall-Fadenschutz verzinkt-passiviert
- Stahlblechfelge
- Flanschlager

Technical description

- sheet steel metal housing
- swivel bearing with double ball race
- zinc passivated

Wheel series 30Cb

- solid rubber tyre blue-grey (Shore A 80)
- sheet steel metal rim
- thread guard zinc passivated
- flange bearing

341a Lenkrolle / Swivel castor

341h Lenkrolle mit Totalfeststeller nachlaufend / Swivel castor with total brake mounted behind

Michelrollen
Furniture castors



341a 30C100b ZLC	100	23	121	28	10,2	65	

Apparaterollen
Apparatus castors



341h 30C100b ZLC	100	23	121	28	10,2	65	

Medizinisch-Technische Rollen
Medical equipment castors



341a 30C100b ZGC	100	23	124	28	M10x25	65	

Transportgeräterollen
Transport appliance castors



341h 30C100b ZGC	100	23	124	28	M10x25	65	

Edelstahlrollen
Stainless steel castors

Schwerlastrollen
Heavy duty castors

Bäckerrollen
Bakery castors

Räder
Wheels

Zubehör
Accessories

Technische Beschreibung

- Stahlblechgehäuse
- verzinkt-passiviert
- Schwenklager mit zweireihigem Kugellauf

Radserie 30Cb

- Vollgummireifen blaugrau (Shore A 80)
- Metall-Fadenschutz verzinkt-passiviert
- Stahlblechfelge
- Flanschlager

Technical description

- sheet steel metal housing
- swivel bearing with double ball race
- zinc passivated

Wheel series 30Cb

- solid rubber tyre blue-grey (Shore A 80)
- sheet steel metal rim
- thread guard zinc passivated
- flange bearing

341a Lenkrolle / Swivel castor

341h Lenkrolle mit Totalfeststeller nachlaufend / Swivel castor with total brake mounted behind



341a 30C100b ZR	100	23	124	28	65	



341h 30C100b ZR	100	23	124	28	65	

Technische Beschreibung

- Stahlblechgehäuse
- verzinkt-passiviert
- Schwenklager mit zweireihigem Kugellauf
- Befestigung siehe Kapitel »Zubehör«

Radserie 30Cb

- Vollgummireifen blaugrau (Shore A 80)
- Metall-Fadenschutz verzinkt-passiviert
- Stahlblechfelge
- Flanschlager

Technical description

- sheet steel metal housing
- swivel bearing with double ball race
- zinc passivated
- attachment see chapter »Accessories«

Wheel series 30Cb

- solid rubber tyre blue-grey (Shore A 80)
- sheet steel metal rim
- thread guard zinc passivated
- flange bearing

340a Lenkrolle / Swivel castor

340b Lenkrolle mit Radfeststeller / Swivel castor with wheel locking brake

341h Lenkrolle mit Totalfeststeller nachlaufend / Swivel castor with total brake mounted behind

345a Bockrolle / Fixed castor

Möbelrollen
Furniture castors

Apparaterollen
Apparatus castors

Medizinisch-Technische Rollen
Medical equipment castors

Transportgeräterollen
Transport appliance castors

Edelstahlrollen
Stainless steel castors

Schwerlastrollen
Heavy duty castors

Bäckerrollen
Bakery castors

Räder
Wheels

Zubehör
Accessories



340a 33C050b ZPB	50	18	70	24	54x54	6,3	40x40	40	
341a 33C075b ZPC	75	23	103	37	60x60	6,3	47x47/37x37	50	



340b 33C050b ZPB	50	18	70	24	54x54	6,3	40x40	40	



341h 33C075b ZPC	75	23	103	37	60x60	6,3	47x47/37x37	50	



345a 33C050b ZPB	50	18	70	54x54	6,3	40x40	40		
346a 33C075b ZPC	75	23	103	60x60	6,3	47x47/37x37	50		

Technische Beschreibung

- Stahlblechgehäuse
- Schwenklager mit zweireihigem Kugellager
- verzinkt-passiviert

Radserie 33Cb

- Vollgummireifen blaugrau (Shore A 80)
- Kunststoff-Radkörper grau
- Metall-Fadenschutz verzinkt-passiviert (ab Ø 75 mm)
- Flanschlager

Technical description

- sheet steel metal housing
- swivel bearing with double ball race
- zinc passivated

Wheel series 33Cb

- solid rubber tyre blue-grey (Shore A 80)
- plastic wheel centre grey
- metal thread guard zinc-passivated (from Ø 75 mm)
- flange bearing

340a Lenkrolle / Swivel castor

340b Lenkrolle mit Radfeststeller / Swivel castor with wheel locking brake

341h Lenkrolle mit Totalfeststeller nachlaufend / Swivel castor with total brake mounted behind



340a 33C050b ZLC	50	18	67	24	10,2	40	
341a 33C075b ZLC	75	23	100	37	10,2	50	



340b 33C050b ZLC	50	18	67	24	10,2	40	



341h 33C075b ZLC	75	23	100	37	10,2	50	

Technische Beschreibung

- Stahlblechgehäuse
- Schwenklager mit zweireihigem Kugellauf
- verzinkt-passiviert

Radserie 33Cb

- Vollgummireifen blaugrau (Shore A 80)
- Kunststoff-Radkörper grau
- Metall-Fadenschutz verzinkt-passiviert (ab Ø 75 mm)
- Flanschlager

Technical description

- sheet steel metal housing
- swivel bearing with double ball race
- zinc passivated

Wheel series 33Cb

- solid rubber tyre blue-grey (Shore A 80)
- plastic wheel centre grey
- metal thread guard zinc-passivated (from Ø 75 mm)
- flange bearing

340a Lenkrolle / Swivel castor

340b Lenkrolle mit Radfeststeller / Swivel castor with wheel locking brake

341h Lenkrolle mit Totalfeststeller nachlaufend / Swivel castor with total brake mounted behind

Möbelrollen
Furniture castors

Apparaterollen
Apparatus castors

Medizinisch-Technische Rollen
Medical equipment castors

Transportgeräterollen
Transport appliance castors

Edelstahlrollen
Stainless steel castors

Schwerlastrollen
Heavy duty castors

Bäckerrollen
Bakery castors

Räder
Wheels

Zubehör
Accessories



340a 33C050b ZGC	50	18	70	24	M10x25	40	
341a 33C075b ZGC	75	23	103	37	M10x25	50	



340b 33C050b ZGC	50	18	70	24	M10x25	40	



341h 33C075b ZGC	75	23	103	37	M10x25	50	

Technische Beschreibung

- Stahlblechgehäuse
- Schwenklager mit zweireihigem Kugellauf
- verzinkt-passiviert

Radserie 33Cb

- Vollgummireifen blaugrau (Shore A 80)
- Kunststoff-Radkörper grau
- Metall-Fadenschutz verzinkt-passiviert (ab Ø 75 mm)
- Flanschlager

Technical description

- sheet steel metal housing
- swivel bearing with double ball race
- zinc passivated

Wheel series 33Cb

- solid rubber tyre blue-grey (Shore A 80)
- plastic wheel centre grey
- metal thread guard zinc-passivated (from Ø 75 mm)
- flange bearing

340a Lenkrolle / Swivel castor

340b Lenkrolle mit Radfeststeller / Swivel castor with wheel locking brake

341h Lenkrolle mit Totalfeststeller nachlaufend / Swivel castor with total brake mounted behind



340a 33C050b ZR	50	18	70	24	40	
341a 33C075b ZR	75	23	103	37	50	



340b 33C050b ZR	50	18	70	24	40	



341h 33C075b ZR	75	23	103	37	50	

Technische Beschreibung

- Stahlblechgehäuse
- Schwenklager mit zweireihigem Kugellauf
- verzinkt-passiviert
- Befestigung siehe Kapitel »Zubehör«

Radserie 33Cb

- Vollgummireifen blaugrau (Shore A 80)
- Kunststoff-Radkörper grau
- Metall-Fadenschutz verzinkt-passiviert (ab Ø 75 mm)
- Flanschlager

Technical description

- sheet steel metal housing
- swivel bearing with double ball race
- zinc passivated
- attachment see chapter »Accessories«

Wheel series 33Cb

- solid rubber tyre blue-grey (Shore A 80)
- plastic wheel centre grey
- metal thread guard zinc-passivated (from Ø 75 mm)
- flange bearing

GML Lenkrolle / Swivel castor

GMF Lenkrolle mit Totalfeststeller nachlaufend / Swivel castor with total brake mounted behind

Möbelrollen
Furniture castors

Apparaterollen
Apparatus castors

Medizinisch-Technische Rollen
Medical equipment castors

Transportgeräterollen
Transport appliance castors

Edelstahlrollen
Stainless steel castors

Schwerlastrollen
Heavy duty castors

Bäckerrollen
Bakery castors

Räder
Wheels

Zubehör
Accessories



GML-21C-L10	50	22	22	69	23	11	48	50	
GML-31C-L10	75	28	28	98	24	11	62	60	
GML-41C-L10	100	30	30	122	25	11	75	75	



GMF-21C-L10	50	22	22	69	23	11	75	50	
GMF-31C-L10	75	28	28	98	24	11	81	60	
GMF-41C-L10	100	30	30	122	25	11	90	75	

Technische Beschreibung

- Stahlblechgehäuse
- Schwenklager mit zweireihigem Kugellauf
- verzinkt-passiviert

Radserie VIVAX-1C

- Polypropylen-Radkörper
- thermoplastische Bandage (TPE, Shore A 87)
- Fadenschutz
- Kugellager
- nicht ausölend

Technical description

- sheet steel metal housing
- swivel bearing with double ball race
- zinc passivated

Wheel series VIVAX-1C

- TPE tread (Shore A 87)
- polypropylene wheel body
- thread guard
- ball bearing
- non-oiling
- on request further variants available

GML Lenkrolle / Swivel castor

GMF Lenkrolle mit Totalfeststeller nachlaufend / Swivel castor with total brake mounted behind

GMR Bockrolle / Fixed castor



GML-21C-P60	50	22	22	69	23	60x60	6,5	38x38/48x48	48	50
GML-31C-P60	75	28	28	98	24	60x60	6,5	38x38/48x48	62	60
GML-41C-P60	100	30	30	122	25	60x60	6,5	38x38/48x48	75	75



GMF-21C-P60	50	30	22	69	23	60x60	6,5	38x38/48x48	75	75
GMF-31C-P60	75	30	28	98	24	60x60	6,5	38x38/48x48	81	75
GMF-41C-P60	100	30	30	122	25	60x60	6,5	38x38/48x48	90	75



GMR-21C-P60		50	22	22	69	63x60	6,5	38x38/48x48	50
GMR-31C-P60		75	28	28	100	63x60	6,5	38x38/48x48	60

Technische Beschreibung

- Stahlblechgehäuse
- Schwenklager mit zweireihigem Kugellauf
- verzinkt-passiviert

Radserie VIVAX-1C

- Polypropylen-Radkörper
- thermoplastische Bandage (TPE, Shore A 87)
- Fadenschutz
- Kugellager
- nicht ausölend

Technical description

- sheet steel metal housing
- swivel bearing with double ball race
- zinc passivated

Wheel series VIVAX-1C

- TPE tread (Shore A 87)
- polypropylene wheel body
- thread guard
- ball bearing
- non-oiling
- on request further variants available

GSL Lenkrolle / Swivel castor

GSF Lenkrolle mit Totalfeststeller nachlaufend / Swivel castor with total brake mounted behind

Michelrollen
Furniture castors

Apparaterollen
Apparatus castors

Medizinisch-Technische Rollen
Medical equipment castors

Transportgeräterollen
Transport appliance castors

Edelstahlrollen
Stainless steel castors

Schwerlastrollen
Heavy duty castors

Bäckerrollen
Bakery castors

Räder
Wheels

Zubehör
Accessories



GSL-41C-L10	100	32	36	135	43	11	93	100	
GSL-51C-L10	125	32	36	160	41	11	104	100	
GSL-61C-L10	150	32	36	185	36	11	111	120	
GSL-41C-L12	100	32	36	135	43	12,2	93	100	
GSL-51C-L12	125	32	36	160	41	12,2	104	100	
GSL-61C-L12	150	32	36	185	36	12,2	111	120	
GSF-41C-L10	100	32	36	135	43	11	130	100	
GSF-51C-L10	125	32	36	160	41	11	132	100	
GSF-61C-L10	150	32	36	185	36	11	132	120	
GSF-41C-L12	100	32	36	135	43	12,2	130	100	
GSF-51C-L12	125	32	36	160	41	12,2	132	100	
GSF-61C-L12	150	32	36	185	36	12,2	132	120	

Technische Beschreibung

- Stahlblechgehäuse
- Schwenklager mit zweireihigem Kugellauf
- verzinkt-passiviert

Radserie VIVAX-1C

- Polypropylen-Radkörper
- thermoplastische Bandage (TPE, Shore A 87)
- Fadenschutz
- Kugellager
- nicht ausölend

Technical description

- sheet steel metal housing
- swivel bearing with double ball race
- zinc passivated

Wheel series VIVAX-1C

- TPE tread (Shore A 87)
- polypropylene wheel body
- thread guard
- ball bearing
- non-oiling
- on request further variants available

GSL Lenkrolle / Swivel castor

GSF Lenkrolle mit Totalfeststeller nachlaufend / Swivel castor with total brake mounted behind



GSL-41C-P77		100	32	36	135	43	77x67	8,5	61x51/56x46	93	100		
GSL-51C-P77		125	32	36	160	41	77x67	8,5	61x51/56x46	104	100		
GSL-61C-P77		150	32	36	185	36	77x67	8,5	61x51/56x46	111	120		
GSL-41C-P95		100	32	36	135	43	95x70	8,5	75x50/72x52	93	100		
GSL-51C-P95		125	32	36	160	41	95x70	8,5	75x50/72x52	104	100		
GSL-61C-P95		150	32	36	185	36	95x70	8,5	75x50/72x52	111	120		
GSF-41C-P77		100	32	36	135	43	77x67	8,5	61x51/56x46	130	100		
GSF-51C-P77		125	32	36	160	41	77x67	8,5	61x51/56x46	132	100		
GSF-61C-P77		150	32	36	185	36	77x67	8,5	61x51/56x46	132	120		
GSF-41C-P95		100	32	36	135	43	95x70	8,5	75x50/72x52	130	100		
GSF-51C-P95		125	32	36	160	41	95x70	8,5	75x50/72x52	132	100		
GSF-61C-P95		150	32	36	185	36	95x70	8,5	75x50/72x52	132	120		

Technische Beschreibung

- Stahlblechgehäuse
- Schwenklager mit zweireihigem Kugellauf
- verzinkt-passiviert

Radserie VIVAX-1C

- Polypropylen-Radkörper
- thermoplastische Bandage (TPE, Shore A 87)
- Fadenschutz
- Kugellager
- nicht ausöland

Technical description

- sheet steel metal housing
- swivel bearing with double ball race
- zinc passivated

Wheel series VIVAX-1C

- TPE tread (Shore A 87)
- polypropylene wheel body
- thread guard
- ball bearing
- non-oiling
- on request further variants available

357a Lenkrolle / Swivel castor

357h Lenkrolle mit Totalfeststeller nachlaufend / Swivel castor with total brake mounted behind

357r Lenkrolle mit Richtungsfeststeller / Swivel castor with directional lock

354a Bockrolle / Fixed castor

Möbelrollen
Furniture castors

Apparaterollen
Apparatus castors

Medizinisch-Technische Rollen
Medical equipment castors

Transportgeräterollen
Transport appliance castors

Edelstahlrollen
Stainless steel castors

Schwerlastrollen
Heavy duty castors

Bäckerrollen
Bakery castors

Räder
Wheels

Zubehör
Accessories



357a 29K100r ZPF	100	30	129,5	41,5	95x70	9	75x45/72x52	100	
357a 29K125r ZPF	125	32	154	43,5	95x70	9	75x45/72x52	100	
357a 29K150r ZPF	150	32	180,5	51	95x70	9	75x45/72x52	120	



357h 29K100r ZPF	100	30	129,5	47,5	95x70	9	75x45/72x52	100	
357h 29K125r ZPF	125	32	154	41,5	95x70	9	75x45/72x52	100	
357h 29K150r ZPF	150	32	180,5	38	95x70	9	75x45/72x52	120	



357r 29K100r ZPF	100	30	129,5	47,5	95x70	9	75x45/72x52	100	•
357r 29K125r ZPF	125	32	154	41,5	95x70	9	75x45/72x52	100	•
357r 29K150r ZPF	150	32	180,5	38	95x70	9	75x45/72x52	120	•



354a 29K100r ZPF	100	30	129,5	95x70	9	75x45/72x52	100	
354a 29K125r ZPF	125	32	154	95x70	9	75x45/72x52	100	
354a 29K150r ZPF	150	32	180,5	95x70	9	75x45/72x52	120	

• Artikel auf Anfrage / product on request

Technische Beschreibung

- Stahlblechgehäuse
- Schwenklager mit zweireihigem Kugellauf
- verzinkt-passiviert
- auch mit Platte PD (77x67 mm) und Rückenloch LC (11 mm) lieferbar

Radserie 29Kr

- thermoplastische Elastomer-Bandage (TPE) eisengrau RAL 7011 (Shore A 80)
- Kunststoff-Radkörper und Kunststoff-Fadenschutz silbergrau RAL 7001
- Präzisionskugellager
- Kontaktverfärbung auf unversiegelten Böden möglich!

Technical description

- sheet steel metal housing
- swivel bearing with double ball race
- zinc passivated
- also available with plate PD (77x67 mm) and bolt hole LC (11 mm)

Wheel series 29Kr

- thermoplastic elastomer tyre (TPE) iron grey RAL 7011 (Shore A 80)
- plastic wheel centre and thread guard silver grey RAL7001
- precision ball bearing
- Contact discoloration on unsealed grounds possible!

357a Lenkrolle / Swivel castor

357h Lenkrolle mit Totalfeststeller nachlaufend / Swivel castor with total brake mounted behind



357a 29K100r ZPH-5	100	32	135	38	100x80	9	80x60	90	•
357a 29K125r ZPH-5	125	32	160	41	100x80	9	80x60	110	•
357a 29K150r ZPH-5	150	32	184,5	45	100x80	9	80x60	130	•



357h 29K100r ZPH-5	100	32	135	43,5	100x80	9	80x60	90	•
357h 29K125r ZPH-5	125	32	160	41	100x80	9	80x60	110	•
357h 29K150r ZPH-5	150	32	184,5	36	100x80	9	80x60	130	•

• Artikel auf Anfrage / product on request

Technische Beschreibung

- Stahlblechgehäuse
- Schwenklager mit zweireihigem Kugellauf
- verzinkt-passiviert
- auch mit Rückenloch LC (10,5) und als Lenkrolle mit Richtungsfeststeller (357r) lieferbar

Radserie 29Kr

- thermoplastische Elastomer-Bandage (TPE) eisengrau RAL 7011 (Shore A 80)
- Kunststoff-Radkörper und Kunststoff-Fadenschutz silbergrau RAL 7001
- Präzisionskugellager
- Kontaktverfärbung auf unversiegelten Böden möglich!

Technical description

- sheet steel metal housing
- swivel bearing with double ball race
- zinc passivated
- also available with bolt hole LC (10,5 mm) and swivel castors with directional brake (357r)

Wheel series 29Kr

- thermoplastic elastomer tyre (TPE) iron grey RAL 7011 (Shore A 80)
- plastic wheel centre and thread guard silver grey RAL7001
- precision ball bearing
- Contact discoloration on unsealed grounds possible!

357a Lenkrolle / Swivel castor

357h Lenkrolle mit Totalfeststeller nachlaufend / Swivel castor with total brake mounted behind

357r Lenkrolle mit Richtungsfeststeller / Swivel castor with directional lock

Michelrollen
Furniture castors

Apparaterollen
Apparatus castors

Medizinisch-Technische Rollen
Medical equipment castors

Transportgeräterollen
Transport appliance castors

Edelstahlrollen
Stainless steel castors

Schwerlastrollen
Heavy duty castors

Bäckerrollen
Bakery castors

Räder
Wheels

Zubehör
Accessories



357a 29K100r ZLD	100	30	129,5	41,5	13	100	
357a 29K125r ZLD	125	32	154	43,5	13	100	
357a 29K150r ZLD	150	32	180,5	51	13	120	



357h 29K100r ZLD	100	30	129,5	47,5	13	100	
357h 29K125r ZLD	125	32	154	41,5	13	100	
357h 29K150r ZLD	150	32	180,5	38	13	120	



357r 29K100r ZLD	100	30	129,5	47,5	13	100	•
357r 29K125r ZLD	125	32	154	41,5	13	100	•
357r 29K150r ZLD	150	32	180,5	38	13	120	•

• Artikel auf Anfrage / product on request

Technische Beschreibung

- Stahlblechgehäuse
- Schwenklager mit zweireihigem Kugellager
- verzinkt-passiviert
- auch mit Platte PD (77x67 mm) und Rückenloch LC (11 mm) lieferbar

Radserie 29Kr

- thermoplastische Elastomer-Bandage (TPE) eisengrau RAL 7011 (Shore A 80)
- Kunststoff-Radkörper und Kunststoff-Fadenschutz silbergrau RAL 7001
- Präzisionskugellager
- Kontaktverfärbung auf unversiegelten Böden möglich!

Technical description

- sheet steel metal housing
- swivel bearing with double ball race
- zinc passivated
- also available with plate PD (77x67 mm) and bolt hole LC (11 mm)







Wheel series 29Kr

- thermoplastic elastomer tyre (TPE) iron grey RAL 7011 (Shore A 80)
- plastic wheel centre and thread guard silver grey RAL7001
- precision ball bearing
- Contact discoloration on unsealed grounds possible!







357a Lenkrolle / Swivel castor

357h Lenkrolle mit Totalfeststeller nachlaufend / Swivel castor with total brake mounted behind



							
357a 29K100r ZLD-5	100	32	135	38	12,5	90	•
357a 29K125r ZLD-5	125	32	160	41	12,5	110	•
357a 29K150r ZLD-5	150	32	184,5	45	12,5	130	•



							
357h 29K100r ZLD-5	100	32	135	38	12,5	90	•
357h 29K125r ZLD-5	125	32	160	41	12,5	110	•
357h 29K150r ZLD-5	150	32	184,5	45	12,5	130	•

• Artikel auf Anfrage / product on request

Technische Beschreibung

- Stahlblechgehäuse
- Schwenklager mit zweireihigem Kugellauf
- verzinkt-passiviert
- auch mit Rückenloch LC (10,5) und als Lenkrolle mit Richtungsfeststeller (357r) lieferbar

Radserie 29Kr

- thermoplastische Elastomer-Bandage (TPE) eisengrau RAL 7011 (Shore A 80)
- Kunststoff-Radkörper und Kunststoff-Fadenschutz silbergrau RAL 7001
- Präzisionskugellager
- Kontaktverfärbung auf unversiegelten Böden möglich!

Technical description

- sheet steel metal housing
- swivel bearing with double ball race
- zinc passivated
- also available with bolt hole LC (10,5 mm) and swivel castors with directional brake (357r)

Wheel series 29Kr

- thermoplastic elastomer tyre (TPE) iron grey RAL 7011 (Shore A 80)
- plastic wheel centre and thread guard silver grey RAL7001
- precision ball bearing
- Contact discoloration on unsealed grounds possible!

357a Lenkrolle / Swivel castor

357h Lenkrolle mit Totalfeststeller nachlaufend / Swivel castor with total brake mounted behind

357r Lenkrolle mit Richtungsfeststeller / Swivel castor with directional lock

Möbelrollen
Furniture castors

Apparaterollen
Apparatus castors

Medizinisch-Technische Rollen
Medical equipment castors

Transportgeräterollen
Transport appliance castors

Edelstahlrollen
Stainless steel castors

Schwerlastrollen
Heavy duty castors

Bäckerrollen
Bakery castors

Räder
Wheels

Zubehör
Accessories



357a 29K100r Z522	100	30	132,5	41,5	24x45 M8/19	100		
357a 29K125r Z522	125	32	157	43,5	24x45 M8/19	100		
357a 29K150r Z522	150	32	183,5	51	24x45 M8/19	120		



357h 29K100r Z522	100	30	132,5	47,5	24x45 M8/19	100		
357h 29K125r Z522	125	32	157	41,5	24x45 M8/19	100		
357h 29K150r Z522	150	32	183,5	38	24x45 M8/19	120		



357r 29K100r Z522	100	30	132,5	47,5	24x45 M8/19	100		•
357r 29K125r Z522	125	32	157	41,5	24x45 M8/19	100		•
357r 29K150r Z522	150	32	183,5	38	24x45 M8/19	120		•

• Artikel auf Anfrage / product on request

Technische Beschreibung

- Stahlblechgehäuse
- Schwenklager mit zweireihigem Kugellauf
- verzinkt-passiviert
- auch mit Platte PD (77x67 mm) und Rückenloch LC (11 mm) lieferbar
- Befestigung siehe Kapitel »Zubehör«

Radserie 29Kr

- thermoplastische Elastomer-Bandage (TPE) eisengrau RAL 7011 (Shore A 80)
- Kunststoff-Radkörper und Kunststoff-Fadenschutz silbergrau RAL 7001
- Präzisionskugellager
- Kontaktverfärbung auf unversiegelten Böden möglich!

Technical description

- sheet steel metal housing
- swivel bearing with double ball race
- zinc passivated
- also available with plate PD (77x67 mm) and bolt hole LC (11 mm)
- attachment see chapter »Accessories«







Wheel series 29Kr

- thermoplastic elastomer tyre (TPE) iron grey RAL 7011 (Shore A 80)
- plastic wheel centre and thread guard silver grey RAL7001
- precision ball bearing
- Contact discoloration on unsealed grounds possible!







357a Lenkrolle / Swivel castor

357h Lenkrolle mit Totalfeststeller nachlaufend / Swivel castor with total brake mounted behind



							
357a 29K100r Z622-5	100	32	138,5	38	28x44,5	90	•
357a 29K125r Z622-5	125	32	163,5	41	28x44,5	110	•
357a 29K150r Z622-5	150	32	188	45	28x44,5	130	•



							
357h 29K100r Z622-5	100	32	138,5	43,5	28x44,5	90	•
357h 29K125r Z622-5	125	32	163,5	41	28x44,5	110	•
357h 29K150r Z622-5	150	32	188	36	28x44,5	130	•

• Artikel auf Anfrage / product on request

Technische Beschreibung

- Stahlblechgehäuse
- Schwenklager mit zweireihigem Kugellauf
- verzinkt-passiviert
- auch mit Rückenloch LC (10,5) und als Lenkrolle mit Richtungsfeststeller (357r) lieferbar

Radserie 29Kr

- thermoplastische Elastomer-Bandage (TPE) eisengrau RAL 7011 (Shore A 80)
- Kunststoff-Radkörper und Kunststoff-Fadenschutz silbergrau RAL 7001
- Präzisionskugellager
- Kontaktverfärbung auf unversiegelten Böden möglich!

Technical description

- sheet steel metal housing
- swivel bearing with double ball race
- zinc passivated
- also available with bolt hole LC (10,5 mm) and swivel castors with directional brake (357r)

Wheel series 29Kr

- thermoplastic elastomer tyre (TPE) iron grey RAL 7011 (Shore A 80)
- plastic wheel centre and thread guard silver grey RAL7001
- precision ball bearing
- Contact discoloration on unsealed grounds possible!

357a Lenkrolle / Swivel castor

357h Lenkrolle mit Totalfeststeller nachlaufend / Swivel castor with total brake mounted behind

Michelrollen
Furniture castors

Apparaterollen
Apparatus castors

Medizinisch-Technische Rollen
Medical equipment castors

Transportgeräterollen
Transport appliance castors

Edelstahlrollen
Stainless steel castors

Schwerlastrollen
Heavy duty castors

Bäckerrollen
Bakery castors

Räder
Wheels

Zubehör
Accessories



357a 29K100r ZGD-5	100	32	135	38	M12x30	90	•
357a 29K125r ZGD-5	125	32	160	41	M12x30	110	•
357a 29K150r ZGD-5	150	32	184,5	45	M12x30	130	•

357h 29K100r ZGD-5	100	32	135	43,5	M12x30	90	•
357h 29K125r ZGD-5	125	32	160	41	M12x30	110	•
357h 29K150r ZGD-5	150	32	184,5	36	M12x30	130	•

• Artikel auf Anfrage / product on request

Technische Beschreibung

- Stahlblechgehäuse
- Schwenklager mit zweireihigem Kugellauf
- verzinkt-passiviert
- auch mit Rückenloch LC (10,5) und als Lenkrolle mit Richtungsfeststeller (357r) lieferbar

Radserie 29Kr

- thermoplastische Elastomer-Bandage (TPE) eisengrau RAL 7011 (Shore A 80)
- Kunststoff-Radkörper und Kunststoff-Fadenschutz silbergrau RAL 7001
- Präzisionskugellager
- Kontaktverfärbung auf unversiegelten Böden möglich!

Technical description

- sheet steel metal housing
- swivel bearing with double ball race
- zinc passivated
- also available with bolt hole LC (10,5 mm) and swivel castors with directional brake (357r)

Wheel series 29Kr

- thermoplastic elastomer tyre (TPE) iron grey RAL 7011 (Shore A 80)
- plastic wheel centre and thread guard silver grey RAL7001
- precision ball bearing
- Contact discoloration on unsealed grounds possible!

357a Lenkrolle / Swivel castor

357h Lenkrolle mit Totalfeststeller nachlaufend / Swivel castor with total brake mounted behind

357r Lenkrolle mit Richtungsfeststeller / Swivel castor with directional lock



357a 29K100r ZR	100	30	132,5	41,5	100	
357a 29K125r ZR	125	32	157	43,5	100	
357a 29K150r ZR	150	32	183,5	51	120	



357h 29K100r ZR	100	30	132,5	47,5	100	
357h 29K125r ZR	125	32	157	41,5	100	
357h 29K150r ZR	150	32	183,5	38	120	



357r 29K100r ZR	100	32	132,5	47,5	100	•
357r 29K125r ZR	125	32	157	41,5	100	•
357r 29K150r ZR	150	32	183,5	38	120	•

• Artikel auf Anfrage / product on request

Technische Beschreibung

- Stahlblechgehäuse
- Schwenklager mit zweireihigem Kugellauf
- verzinkt-passiviert
- auch mit Platte PD (77x67 mm) und Rückenloch LC (11 mm) lieferbar
- Befestigung siehe Kapitel »Zubehör«

Radserie 29Kr

- thermoplastische Elastomer-Bandage (TPE) eisengrau RAL 7011 (Shore A 80)
- Kunststoff-Radkörper und Kunststoff-Fadenschutz silbergrau RAL 7001
- Präzisionskugellager
- Kontaktverfärbung auf unversiegelten Böden möglich!

Technical description

- sheet steel metal housing
- swivel bearing with double ball race
- zinc passivated
- also available with plate PD (77x67 mm) and bolt hole LC (11 mm)
- attachment see chapter »Accessories«

Wheel series 29Kr

- thermoplastic elastomer tyre (TPE) iron grey RAL 7011 (Shore A 80)
- plastic wheel centre and thread guard silver grey RAL7001
- precision ball bearing
- Contact discoloration on unsealed grounds possible!

357a Lenkrolle / Swivel castor

357h Lenkrolle mit Totalfeststeller nachlaufend / Swivel castor with total brake mounted behind

357r Lenkrolle mit Richtungsfeststeller / Swivel castor with directional lock

354a Bockrolle / Fixed castor

Möbelrollen
Furniture castors

Apparaterollen
Apparatus castors

Medizinisch-Technische Rollen
Medical equipment castors

Transportgeräterollen
Transport appliance castors

Edelstahlrollen
Stainless steel castors

Schwerlastrollen
Heavy duty castors

Bäckerrollen
Bakery castors

Räder
Wheels

Zubehör
Accessories



357a 29G100r ZPF	100	30	129,5	41,5	95x70	9	75x45/72x52	100		
357a 29G125r ZPF	125	32	154	43,5	95x70	9	75x45/72x52	100		



357h 29G100r ZPF	100	30	129,5	47,5	95x70	9	75x45/72x52	100		
357h 29G125r ZPF	125	32	154	41,5	95x70	9	75x45/72x52	100		



357r 29G100r ZPF	100	30	129,5	47,5	95x70	9	75x45/72x52	100	•	
357r 29G125r ZPF	125	32	154	41,5	95x70	9	75x45/72x52	100	•	



354a 29G100r ZPF	100	30	129,5	95x70	9	75x45/72x52	100			
354a 29G125r ZPF	125	32	154	95x70	9	75x45/72x52	100			

• Artikel auf Anfrage / product on request

Technische Beschreibung

- Stahlblechgehäuse
- Schwenklager mit zweireihigem Kugellauf
- verzinkt-passiviert
- auch mit Platte PD (77x67 mm) und Rückenloch LC (11 mm) lieferbar

Radserie 29Gr

- thermoplastische Elastomer-Bandage (TPE), eisengrau RAL 7011 (Shore A 80)
- Kunststoff-Radkörper silbergrau RAL 7001 ohne Fadenschutz
- Gleitlager
- Kontaktverfärbung auf unversiegelten Böden möglich!

Technical description

- sheet steel metal housing
- swivel bearing with double ball race
- zinc passivated
- also available with plate PD (77x67 mm) and bolt hole LC (11 mm)

Wheel series 29Gr

- thermoplastic elastomer tyre (TPE) iron grey RAL 7011 (Shore A 80)
- plastic wheel centre silver grey RAL7001
- without thread guard
- plain bearing
- Contact discoloration on unsealed grounds possible!

357a Lenkrolle / Swivel castor

357h Lenkrolle mit Totalfeststeller nachlaufend / Swivel castor with total brake mounted behind

357r Lenkrolle mit Richtungsfeststeller / Swivel castor with directional lock



357a 29G100r ZLD	100	30	129,5	41,5	13	100	
357a 29G125r ZLD	125	32	154	43,5	13	100	



357h 29G100r ZLD	100	30	129,5	47,5	13	100	
357h 29G125r ZLD	125	32	154	43,5	13	100	



357r 29G100r ZLD	100	30	129,5	47,5	13	100	•
357r 29G125r ZLD	125	32	154	41,5	13	100	•

• Artikel auf Anfrage / product on request

Technische Beschreibung

- Stahlblechgehäuse
- Schwenklager mit zweireihigem Kugellauf
- verzinkt-passiviert
- auch mit Platte PD (77x67 mm) und Rückenloch LC (11 mm) lieferbar

Radserie 29Gr

- thermoplastische Elastomer-Bandage (TPE), eisengrau RAL 7011 (Shore A 80)
- Kunststoff-Radkörper silbergrau RAL 7001 ohne Fadenschutz
- Gleitlager
- Kontaktverfärbung auf unversiegelten Böden möglich!

Technical description

- sheet steel metal housing
- swivel bearing with double ball race
- zinc passivated
- also available with plate PD (77x67 mm) and bolt hole LC (11 mm)

Wheel series 29Gr

- thermoplastic elastomer tyre (TPE) iron grey RAL 7011 (Shore A 80)
- plastic wheel centre silver grey RAL7001
- without thread guard
- plain bearing
- Contact discoloration on unsealed grounds possible!

357a Lenkrolle / Swivel castor

357h Lenkrolle mit Totalfeststeller nachlaufend / Swivel castor with total brake mounted behind

357r Lenkrolle mit Richtungsfeststeller / Swivel castor with directional lock

Möbelrollen
Furniture castors

Apparaterollen
Apparatus castors

Medizinisch-Technische Rollen
Medical equipment castors

Transportgeräterollen
Transport appliance castors

Edelstahlrollen
Stainless steel castors

Schwerlastrollen
Heavy duty castors

Bäckerrollen
Bakery castors

Räder
Wheels

Zubehör
Accessories



357a 29G100r Z522	100	30	132,5	41,5	24x45 M8/19	100	
357a 29G125r Z522	125	32	157	43,5	24x45 M8/19	100	



357h 29G100r Z522	100	30	132,5	47,5	24x45 M8/19	100	
357h 29G125r Z522	125	32	157	41,5	24x45 M8/19	100	



357r 29G100r Z522	100	30	132,5	47,5	24x45 M8/19	100	•
357r 29G125r Z522	125	32	157	41,5	24x45 M8/19	100	•

• Artikel auf Anfrage / product on request

Technische Beschreibung

- Stahlblechgehäuse
- Schwenklager mit zweireihigem Kugellauf
- verzinkt-passiviert
- auch mit Platte PD (77x67 mm) und Rückenloch LC (11 mm) lieferbar
- Befestigung siehe Kapitel »Zubehör«

Radserie 29Gr

- thermoplastische Elastomer-Bandage (TPE), eisengrau RAL 7011 (Shore A 80)
- Kunststoff-Radkörper silbergrau RAL 7001 ohne Fadenschutz
- Gleitlager
- Kontaktverfärbung auf unversiegelten Böden möglich!

Technical description

- sheet steel metal housing
- swivel bearing with double ball race
- zinc passivated
- also available with plate PD (77x67 mm) and bolt hole LC (11 mm)
- attachment see chapter »Accessories«

Wheel series 29Gr

- thermoplastic elastomer tyre (TPE) iron grey RAL 7011 (Shore A 80)
- plastic wheel centre silver grey RAL7001
- without thread guard
- plain bearing
- Contact discoloration on unsealed grounds possible!

357a Lenkrolle / Swivel castor

357h Lenkrolle mit Totalfeststeller nachlaufend / Swivel castor with total brake mounted behind

357r Lenkrolle mit Richtungsfeststeller / Swivel castor with directional lock



357a 29G100r ZR	100	30	132,5	41,5	100	
357a 29G125r ZR	125	32	157	43,5	100	



357h 29G100r ZR	100	30	132,5	47,5	100	
357h 29G125r ZR	125	32	157	41,5	100	



357r 29G100r ZR	100	30	132,5	47,5	100	•
357r 29G125r ZR	125	32	157	41,5	100	•

• Artikel auf Anfrage / product on request

Technische Beschreibung

- Stahlblechgehäuse
- Schwenklager mit zweireihigem Kugellauf
- verzinkt-passiviert
- auch mit Platte PD (77x67 mm) und Rückenloch LC (11 mm) lieferbar
- Befestigung siehe Kapitel »Zubehör«

Radserie 29Gr

- thermoplastische Elastomer-Bandage (TPE), eisengrau RAL 7011 (Shore A 80)
- Kunststoff-Radkörper silbergrau RAL 7001 ohne Fadenschutz
- Gleitlager
- Kontaktverfärbung auf unversiegelten Böden möglich!

Technical description

- sheet steel metal housing
- swivel bearing with double ball race
- zinc passivated
- also available with plate PD (77x67 mm) and bolt hole LC (11 mm)
- attachment see chapter »Accessories«

Wheel series 29Gr

- thermoplastic elastomer tyre (TPE) iron grey RAL 7011 (Shore A 80)
- plastic wheel centre silver grey RAL7001
- without thread guard
- plain bearing
- Contact discoloration on unsealed grounds possible!

357a Lenkrolle / Swivel castor

357h Lenkrolle mit Totalfeststeller nachlaufend / Swivel castor with total brake mounted behind

357r Lenkrolle mit Richtungsfeststeller / Swivel castor with directional lock

354a Bockrolle / Fixed castor

Möbelrollen
Furniture castors

Apparaterollen
Apparatus castors

Medizinisch-Technische Rollen
Medical equipment castors

Transportgeräterollen
Transport appliance castors

Edelstahlrollen
Stainless steel castors

Schwerlastrollen
Heavy duty castors

Bäckerrollen
Bakery castors

Räder
Wheels

Zubehör
Accessories



357a 32C100b ZPF	100	32	129,5	41,5	95x70	9	75x45/72x52	80		
357a 32C125b ZPF	125	32	154	43,5	95x70	9	75x45/72x52	100		
357a 32C150b ZPF	150	32	180,5	51	95x70	9	75x45/72x52	110		



357h 32C100b ZPF	100	32	129,5	47,5	95x70	9	75x45/72x52	80		
357h 32C125b ZPF	125	32	154	41,5	95x70	9	75x45/72x52	100		
357h 32C150b ZPF	150	32	180,5	38	95x70	9	75x45/72x52	110		



357r 32C100b ZPF	100	32	129,5	47,5	95x70	9	75x45/72x52	80	•	
357r 32C125b ZPF	125	32	154	41,5	95x70	9	75x45/72x52	100	•	
357r 32C150b ZPF	150	32	180,5	38	95x70	9	75x45/72x52	110	•	



354a 32C100bZPF	100	32	129,5	95x70	9	75x45/72x52	80		
354a 32C125b ZPF	125	32	154	95x70	9	75x45/72x52	100		
354a 32C150b ZPF	150	32	180,5	95x70	9	75x45/72x52	110		

• Artikel auf Anfrage / product on request

Technische Beschreibung

- Stahlblechgehäuse
- Schwenklager mit zweireihigem Kugellauf
- verzinkt-passiviert
- auch mit Platte PD (77x67 mm) und Rückenloch LC (11 mm) lieferbar

Radserie 32Cb

- Vollgummireifen blaugrau (Shore A 80)
- Stahlblechfelge und Metall-Fadenschutz verzinkt-passiviert
- Flanschlager

Technical description

- sheet steel metal housing
- swivel bearing with double ball race
- zinc passivated
- also available with plate PD (77x67 mm) and bolt hole LC (11 mm)

Wheel series 32Cb

- solid rubber tyre blue-grey (Shore A 80)
- sheet steel metal rim zinc passivated
- metal thread guard
- flange bearing

357a Lenkrolle / Swivel castor

357h Lenkrolle mit Totalfeststeller nachlaufend / Swivel castor with total brake mounted behind

357r Lenkrolle mit Richtungsfeststeller / Swivel castor with directional lock



357a 32C100b ZLD	100	32	129,5	41,5	13	80	
357a 32C125b ZLD	125	32	154	43,5	13	100	
357a 32C150b ZLD	150	32	180,5	51	13	110	



357h 32C100b ZLD	100	32	129,5	47,5	13	80	
357h 32C125b ZLD	125	32	154	41,5	13	100	
357h 32C150b ZLD	150	32	180,5	38	13	110	



357r 32C100b ZLD	100	32	129,5	47,5	13	80	•
357r 32C125b ZLD	125	32	154	41,5	13	100	•
357r 32C150b ZLD	150	32	180,5	38	13	110	•

• Artikel auf Anfrage / product on request

Technische Beschreibung

- Stahlblechgehäuse
- Schwenklager mit zweireihigem Kugellauf
- verzinkt-passiviert
- auch mit Platte PD (77x67 mm) und Rückenloch LC (11 mm) lieferbar

Radserie 32Cb

- Vollgummireifen blaugrau (Shore A 80)
- Stahlblechfelge und Metall-Fadenschutz verzinkt-passiviert
- Flanschlager

Technical description

- sheet steel metal housing
- swivel bearing with double ball race
- zinc passivated
- also available with plate PD (77x67 mm) and bolt hole LC (11 mm)

Wheel series 32Cb

- solid rubber tyre blue-grey (Shore A 80)
- sheet steel metal rim zinc passivated
- metal thread guard
- flange bearing

357a Lenkrolle / Swivel castor

357h Lenkrolle mit Totalfeststeller nachlaufend / Swivel castor with total brake mounted behind

357r Lenkrolle mit Richtungsfeststeller / Swivel castor with directional lock

Möbelrollen
Furniture castors

Apparaterollen
Apparatus castors

Medizinisch-Technische Rollen
Medical equipment castors

Transportgeräterollen
Transport appliance castors

Edelstahlrollen
Stainless steel castors

Schwerlastrollen
Heavy duty castors

Bäckerrollen
Bakery castors

Räder
Wheels

Zubehör
Accessories



357a 32C100b Z522	100	32	132,5	41,5	24x45 M8/19	80	
357a 32C125b Z522	125	32	157	43,5	24x45 M8/19	100	
357a 32C150b Z522	150	32	183,5	51	24x45 M8/19	110	



357h 32C100b Z522	100	32	132,5	47,5	24x45 M8/19	80	
357h 32C125b Z522	125	32	157	41,5	24x45 M8/19	100	
357h 32C150b Z522	150	32	183,5	38	24x45 M8/19	110	



357r 32C100b Z522	100	32	132,5	47,5	24x45 M8/19	80	•
357r 32C125b Z522	125	32	157	41,5	24x45 M8/19	100	•
357r 32C150b Z522	150	32	183,5	38	24x45 M8/19	110	•

• Artikel auf Anfrage / product on request

Technische Beschreibung

- Stahlblechgehäuse
- Schwenklager mit zweireihigem Kugellauf
- verzinkt-passiviert
- auch mit Platte PD (77x67 mm) und Rückenloch LC (11 mm) lieferbar
- Befestigung siehe Kapitel »Zubehör«

Radserie 32Cb

- Vollgummireifen blaugrau (Shore A 80)
- Stahlblechfelge und Metall-Fadenschutz verzinkt-passiviert
- Flanschlager

Technical description

- sheet steel metal housing
- swivel bearing with double ball race
- zinc passivated
- also available with plate PD (77x67 mm) and bolt hole LC (11 mm)
- attachment see chapter »Accessories«

Wheel series 32Cb

- solid rubber tyre blue-grey (Shore A 80)
- sheet steel metal rim zinc passivated
- metal thread guard
- flange bearing

357a Lenkrolle / Swivel castor

357h Lenkrolle mit Totalfeststeller nachlaufend / Swivel castor with total brake mounted behind

357r Lenkrolle mit Richtungsfeststeller / Swivel castor with directional lock



357a 32C100b ZR	100	32	132,5	41,5	80	
357a 32C125b ZR	125	32	157	43,5	100	
357a 32C150b ZR	150	32	183,5	51	110	



357h 32C100b ZR	100	32	132,5	47,5	80	
357h 32C125b ZR	125	32	157	41,5	100	
357h 32C150b ZR	150	32	183,5	38	110	



357r 32C100b ZR	100	32	132,5	47,5	80	•
357r 32C125b ZR	125	32	157	41,5	100	•
357r 32C150b ZR	150	32	183,5	38	110	•

• Artikel auf Anfrage / product on request

Technische Beschreibung

- Stahlblechgehäuse
- Schwenklager mit zweireihigem Kugellauf
- verzinkt-passiviert
- auch mit Platte PD (77x67 mm) und Rückenloch LC (11 mm) lieferbar
- Befestigung siehe Kapitel »Zubehör«

Radserie 32Cb

- Vollgummireifen blaugrau (Shore A 80)
- Stahlblechfelge und Metall-Fadenschutz verzinkt-passiviert
- Flanschlager

Technical description

- sheet steel metal housing
- swivel bearing with double ball race
- zinc passivated
- also available with plate PD (77x67 mm) and bolt hole LC (11 mm)
- attachment see chapter »Accessories«

Wheel series 32Cb

- solid rubber tyre blue-grey (Shore A 80)
- sheet steel metal rim zinc passivated
- metal thread guard
- flange bearing

DML Lenkrolle / Swivel castor

DMF Lenkrolle mit Totalfeststeller nachlaufend / Swivel castor with total brake mounted behind

Möbelrollen
Furniture castors

Apparaterollen
Apparatus castors

Medizinisch-Technische Rollen
Medical equipment castors

Transportgeräterollen
Transport appliance castors

Edelstahlrollen
Stainless steel castors

Schwerlastrollen
Heavy duty castors

Bäckerrollen
Bakery castors

Räder
Wheels

Zubehör
Accessories



DML-21C-L10	50	2x18	44	72	30	10	55	60				



DMF-21C-L10	50	2x18	44	72	30	10	87	60				



DML-21C-P60	50	2x18	44	72	30	60x60	6,2	38x38/48x48	55	60		



DMF-21C-P60	50	2x18	44	72	30	60x60	6,2	38x38/48x48	87	60		

Technische Beschreibung

- Stahlblechgehäuse
- verzinkt-passiviert
- Schwenklager mit zweireihigem Kugellauf

Radserie VIVAX-1C-Doppelrad für Serie DM,DS

- Doppelrad
- Polypropylen-Radkörper
- thermoplastische Bandage (TPE, Shore A 87)
- Fadenschutz
- Kugellager
- nicht ausölend

Technical description

- sheet steel metal housing
- swivel bearing with double ball race
- zinc passivated

Wheel series VIVAX-1C-Doppelrad für Serie DM,DS

- double wheel
- TPE tread (Shore A 87)
- polypropylene wheel body
- thread guard
- ball bearing
- non-oiling

DSL Lenkrolle / Swivel castor

DSF Lenkrolle mit Totalfeststeller nachlaufend / Swivel castor with total brake mounted behind



DSL-31C-L10	75	2x25	60	99	30	10	68	100		



DSF-31C-L10	75	2x25	60	99	30	10	99	100		



DSL-31C-P77	75	2x25	60	103	30	77x66	8,5	61x51/56x46	68	100	



DSF-31C-P77	75	2x25	60	103	30	77x66	8,5	61x51/56x46	99	100	

Technische Beschreibung

- Stahlblechgehäuse
- verzinkt-passiviert
- Schwenklager mit zweireihigem Kugellauf

Radserie VIVAX-1C-Doppelrad für Serie DM,DS

- Doppelrad
- Polypropylen-Radkörper
- thermoplastische Bandage (TPE, Shore A 87)
- Fadenschutz
- Kugellager
- nicht ausölen

Technical description

- sheet steel metal housing
- swivel bearing with double ball race
- zinc passivated

Wheel series VIVAX-1C-Doppelrad für Serie DM,DS

- double wheel
- TPE tread (Shore A 87)
- polypropylene wheel body
- thread guard
- ball bearing
- non-oiling

360a Lenkrolle / Swivel castor

360h Lenkrolle mit Totalfeststeller nachlaufend / Swivel castor with total brake mounted behind

Möbelrollen
Furniture castors



360a 00G050x ZPC	50	2X20	73	25	60x60	6	46x46	60	
360a 00G075x ZPC	50	2X22	101	35	60x60	6	46x46	60	

Apparaterollen
Apparatus castors



360h 00G050x ZPC	50	2X20	73	25	60x60	6	46x46	60	
360h 00G075x ZPC	50	2X22	101	35	60x60	6	46x46	60	

Medizinisch-Technische Rollen
Medical equipment castors



360a 00G050x ZLC	50	2x20	73	25		10	60	
360a 00G075x ZLC	75	2x22	98,5	35		10	80	

Transportgeräterollen
Transport appliance castors



360h 00G050x ZLC	50	2x20	73	25		10	60
360h 00G075x ZLC	75	2x22	98,5	35		10	80

Edelstahlrollen
Stainless steel castors

Schwerlastrollen
Heavy duty castors

Bäckerrollen
Bakery castors

Räder
Wheels

Zubehör
Accessories

Technische Beschreibung

- Stahlblechgehäuse
- verzinkt-passiviert
- Schwenklager mit zweireihigem Kugellauf

Radserie 00Gx

- Polyamid schwarz
- Gleitlager

Technical description

- sheet steel metal housing
- swivel bearing with double ball race
- zinc passivated

Wheel series 00Gx

- polyamide black
- plain bearing

360a Lenkrolle / Swivel castor

360h Lenkrolle mit Totalfeststeller nachlaufend / Swivel castor with total brake mounted behind



360a 33C050b ZPC	50	2x18	73	25	60x60	6	46x46	60	
360a 33C075b ZPC	75	2x22	101	35	60x60	6	46x46	80	



360h 33C050b ZPC	50	2x18	73	25	60x60	6	46x46	60	
360h 33C075b ZPC	75	2x22	101	35	60x60	6	46x46	80	



360a 33C050b ZLC	50	2x18	73	25		10	60	
360a 33C075b ZLC	75	2x22	98,5	35		10	80	



360h 33C050b ZLC	50	2x18	73	25		10	60	
360h 33C075b ZLC	75	2x22	98,5	35		10	80	

Technische Beschreibung

- Stahlblechgehäuse
- verzinkt-passiviert
- Schwenklager mit zweireihigem Kugellauf

Radserie 33Cb

- Vollgummireifen blaugrau (Shore A 80)
- Kunststoff-Radkörper grau
- Metall-Fadenschutz verzinkt-passiviert (ab Ø 75 mm)
- Flanschlager

Technical description

- sheet steel metal housing
- swivel bearing with double ball race
- zinc passivated

Wheel series 33Cb

- solid rubber tyre blue-grey (Shore A 80)
- plastic wheel centre grey
- metal thread guard zinc-passivated (from Ø 75 mm)
- flange bearing

360a Lenkrolle / Swivel castor

360h Lenkrolle mit Totalfeststeller nachlaufend / Swivel castor with total brake mounted behind

Möbelrollen
Furniture castors



360a 33G050b ZPC	50	2x18	73	25	60x60	6	46x46	60	
360a 33G075b ZPC	50	2x24	101	35	60x60	6	46x46	80	

Apparaterollen
Apparatus castors



360h 33G050b ZPC	50	2x18	73	25	60x60	6	46x46	60	
360h 33G075b ZPC	50	2x24	101	35	60x60	6	46x46	80	

Medizinisch-Technische Rollen
Medical equipment castors



360a 33G050b ZLC	50	2x18	73	25		10		60	
360a 33G075b ZLC	75	2x18	98,5	35		10		80	

Transportgeräterollen
Transport appliance castors



360h 33G050b ZLC	50	2x18	73	25		10		60	
360h 33G075b ZLC	75	2x18	98,5	35		10		80	

Edelstahlrollen
Stainless steel castors

Schwerlastrollen
Heavy duty castors

Bäckerrollen
Bakery castors

Räder
Wheels

Zubehör
Accessories

Technische Beschreibung

- Stahlblechgehäuse
- verzinkt-passiviert
- Schwenklager mit zweireihigem Kugellauf

Radserie 33Gb

- Vollgummireifen blaugrau (Shore A 80)
- Kunststoff-Radkörper schwarz
- Gleitlager

Technical description

- sheet steel metal housing
- swivel bearing with double ball race
- zinc passivated

Wheel series 33Gb

- solid rubber tyre blue-grey (Shore A 80)
- plastic wheel centre grey
- plain bearing

361a Lenkrolle / Swivel castor

361b Lenkrolle mit Radfeststeller / Swivel castor with wheel locking brake



361a 33C075p ZPS	75	2x23	102	28,5		55x70	5,5	51/57x41	100	



361b 33C075p ZPS	75	2x23	102	28,5		55x70	5,5	51/57x41	100	



361a 34C075v GPS	75	2x23	102	28,5		55x70	5,5	51/57x41	100	



361b 34C075v GPS	75	2x23	102	28,5		55x70	5,5	51/57x41	100	

Technische Beschreibung

- Stahlblechgehäuse
- mit zweireihigem Kugellauf
- verzinkt-passiviert (361-ZPS)
- gelb-chromatiert (361-GPS)

Radserie 33Cp

- Vollgummireifen blaugrau mit Profil (Shore A 80)
- Kunststoff-Radkörper grau
- Metall-Fadenschutz verzinkt-passiviert
- Flanschlager

Radserie 34Cv

- Polyurethan-Bandage eisengrau RAL 7011 (Shore A 95)
- Kunststoff-Radkörper und Kunststoff-Fadenschutz silbergrau RAL 7001
- Kugellager

Technical description

- sheet steel metal housing
- with double ball race
- zinc passivated (361-ZPS)
- yellow chrome plated (361-GPS)

Wheel series 33Cp

- solid rubber tyre blue-grey with profile (Shore A 80)
- plastic wheel centre grey
- metal thread guard zinc-passivated
- flange bearing

Wheel series 34Cv

- polyurethane tyre iron grey RAL 7011 (Shore A 95)
- plastic wheel centre and plastic thread guard silver grey RAL 7001
- ball bearing

362a Lenkrolle / Swivel castor

Möbelrollen
Furniture castors

Apparaterollen
Apparatus castors

Medizinisch-Technische Rollen
Medical equipment castors

Transportgeräterollen
Transport appliance castors

Edelstahlrollen
Stainless steel castors

Schwerlastrollen
Heavy duty castors

Bäckerrollen
Bakery castors

Räder
Wheels

Zubehör
Accessories



362a 33C075b ZLC	75	23	100	30	10,2	55	



362a 33G075b ZLC	75	23	100	30	10,2	55	



362a 29K100r ZLD	100	30	130	37	12,2	100	
362a 29K125r ZLD	125	32	155	38	12,2	100	

Technische Beschreibung

- Stahlblechgehäuse
- verzinkt-passiviert
- Schwenklager mit zweireihigem Kugellauf
- auf Anfrage auch mit Gewindestift (ZGI) und Flachzapfen (ZCS) lieferbar

Radserie 33Fb

- Vollgummireifen blaugrau (Shore A 80)
- Kunststoff-Radkörper grau
- Metall-Fadenschutz verzinkt-passiviert (ab Ø 75 mm)
- Flanschlager

Radserie 33Gb

- Vollgummireifen blaugrau (Shore A 80)
- Kunststoff-Radkörper schwarz
- Gleitlager

Radserie 29Kr

- thermoplastische Elastomer-Bandage (TPE) eisengrau RAL 7011 (Shore A 80)
- Kunststoff-Radkörper und Kunststoff-Fadenschutz silbergrau RAL 7001
- Präzisionskugellager
- Kontaktverfärbung auf unversiegelten Böden möglich!

Technical description

- sheet steel metal
- swivel bearing with double ball race
- zinc passivated
- also available with bolt hole LC (10,2 mm)
- on inquiry also available with threaded (ZGI) and flat stem (ZCS)

Wheel series 33Fb

- solid rubber tyre blue-grey (Shore A 80)
- plastic wheel centre grey
- metal thread guard zinc-passivated (from Ø 75 mm)
- flange bearing

Wheel series 33Gb

- solid rubber tyre blue-grey (Shore A 80)
- plastic wheel centre grey
- plain bearing

Wheel series 29Kr

- thermoplastic elastomer tyre (TPE) iron grey RAL 7011 (Shore A 80)
- plastic wheel centre and thread guard silver grey RAL7001
- precision ball bearing
- Contact discoloration on unsealed grounds possible!

362a Lenkrolle / Swivel castor



362a 32C100b ZLD	100	30	130	37	12,2	80	
362a 32C125b ZLD	125	32	155	38	12,2	100	



362a 36K125b ZLD	125	32	155	38	12,2	100	

Technische Beschreibung

- Stahlblechgehäuse
- verzinkt-passiviert
- Schwenklager mit zweireihigem Kugellauf
- auf Anfrage auch mit Gewindestift (ZGI) und Flachzapfen (ZCS) lieferbar

Radserie 32Cb

- Vollgummireifen blaugrau (Shore A 80)
- Stahlblechfelge und Metall-Fadenschutz verzinkt-passiviert
- Flanschlager

Radserie 36Kb

- Vollgummireifen eisengrau RAL 7011 (Shore A 80)
- Kunststoff-Radkörper
- und Kunststoff-Fadenschutz silbergrau RAL 7001
- Präzisionskugellager

Technical description

- sheet steel metal
- swivel bearing with double ball race
- zinc passivated
- also available with bolt hole LC (10,2 mm)
- on inquiry also available with threaded (ZGI) and flat stem (ZCS)

Wheel series 32Cb

- solid rubber tyre blue-grey (Shore A 80)
- sheet steel metal rim zinc passivated
- metal thread guard
- flange bearing

Wheel series 36Kb

- solid rubber tyre iron-grey RAL 7011 (Shore A 80)
- plastic wheel centre and plastic thread guard silver grey RAL 7001
- precision ball bearing

363b Lenkrolle mit Totalfeststeller nachlaufend / Swivel castor with total brake mounted behind

363b Lenkrolle mit Radfeststeller / Swivel castor with wheel locking brake

Möbelrollen
Furniture castors

Apparaterollen
Apparatus castors

Medizinisch-Technische Rollen
Medical equipment castors

Transportgeräterollen
Transport appliance castors

Edelstahlrollen
Stainless steel castors

Schwerlastrollen
Heavy duty castors

Bäckerrollen
Bakery castors

Räder
Wheels

Zubehör
Accessories



363b 62C125v ZLD	125	150	43	12,2	60	



363b 810 7575-1	125	150	43	12,2	60	



363b68K125vZLD_B	125	150	43	8	60	•

• Artikel auf Anfrage / product on request

Technische Beschreibung

- Stahlblechgehäuse
- verzinkt-passiviert
- Schwenklager mit zweireihigem Kugellauf
- auch mit Rückenloch LC (10,2 mm) lieferbar
- auf Anfrage auch mit Gewindestift (ZGI) und Flachzapfen (ZCS) lieferbar

Radserie 62Cv/68Kv

- Polyamid-Differentialrad mit Laufring aus Polyurethan
- schwarzer Hartgummi-Bremsring
- Kugellager

Technical description

- sheet steel metal housing
- swivel bearing with double ball race
- zinc passivated
- also available with bolt hole LC (10,2 mm)
- on inquiry also available with threaded (ZGI) and flat stem (ZCS)

Wheel series 62Cv/68Kv

- polyamid differential wheel with raceway of polyurethane
- black hard rubber brake ring
- ball bearing

367a Lenkrolle / Swivel castor

367h Lenkrolle mit Totalfeststeller nachlaufend / Swivel castor with total brake mounted behind

364a Bockrolle / Fixed castor



367a 29K080r ZPF	80	30	117	43,5	95x70	9	75x45/72x52	100	
367a 29K100r ZPF	100	30	138	41,5	95x70	9	75x45/72x52	100	
367a 29K125r ZPF	125	32	162,5	43,5	95x70	9	75x45/72x52	100	
367a 29K150r ZPF	150	32	189	51	95x70	9	75x45/72x52	120	
367a 29K200r ZPF	200	32	241	61	95x70	9	75x45/72x52	120	
367h 29K080r ZPF	80	30	117	43,5	95x70	9	75x45/72x52	100	
367h 29K100r ZPF	100	30	138	41,5	95x70	9	75x45/72x52	100	
367h 29K125r ZPF	125	32	162,5	43,5	95x70	9	75x45/72x52	100	
367h 29K150r ZPF	150	32	189	51	95x70	9	75x45/72x52	120	
367h 29K200r ZPF	200	32	241	61	95x70	9	75x45/72x52	120	
364a 29K080r ZPF	80	30	117		95x70	9	75x45/72x52	100	
364a 29K100r ZPF	100	30	138		95x70	9	75x45/72x52	100	
364a 29K125r ZPF	125	32	162,5		95x70	9	75x45/72x52	100	
364a 29K150r ZPF	150	32	189		95x70	9	75x45/72x52	120	
364a 29K200r ZPF	200	32	241		95x70	9	75x45/72x52	120	

Technische Beschreibung

- Stahlblechgehäuse
- verzinkt-passiviert
- Schwenklager mit zweireihigem Kugellauf
- staub- und spritzwassergeschützt durch Kunststoff-Dichtring
- auch mit Platte PD (77x67 mm) und Rückenloch LC (10,2 mm) lieferbar

Radserie 29Kr

- thermoplastische Elastomer-Bandage (TPE) eisengrau RAL 7011 (Shore A 80)
- Kunststoff-Radkörper und Kunststoff-Fadenschutz silbergrau RAL 7001
- Präzisionskugellager
- Kontaktverfärbung auf unversiegelten Böden möglich!

Technical description

- sheet steel metal housing
- zinc passivated
- swivel bearing with double ball race
- protected from dust and water spray with plastic seal
- also available with plate PD (77x67 mm)
- also available with bolt hole LC (10,2 mm)

Wheel series 29Kr

- thermoplastic elastomer tyre (TPE) iron grey RAL 7011 (Shore A 80)
- plastic wheel centre and thread guard silver grey RAL7001
- precision ball bearing
- Contact discoloration on unsealed grounds possible!

367a Lenkrolle / Swivel castor

367h Lenkrolle mit Totalfeststeller nachlaufend / Swivel castor with total brake mounted behind

Möbelrollen
Furniture castors

Apparaterollen
Apparatus castors

Medizinisch-Technische Rollen
Medical equipment castors

Transportgeräterollen
Transport appliance castors

Edelstahlrollen
Stainless steel castors

Schwerlastrollen
Heavy duty castors

Bäckerrollen
Bakery castors

Räder
Wheels

Zubehör
Accessories



367a 29K080r ZLD	80	30	110	43,5	12,2	100	
367a 29K100r ZLD	100	30	131	41,5	12,2	100	
367a 29K125r ZLD	125	32	155,5	43,5	12,2	100	
367a 29K150r ZLD	150	32	182	51	12,2	120	
367a 29K200r ZLD	200	32	234	61	12,2	120	
367h 29K080r ZLD	80	30	110	43,5	12,2	100	
367h 29K100r ZLD	100	30	131	41,5	12,2	100	
367h 29K125r ZLD	125	32	155,5	43,5	12,2	100	
367h 29K150r ZLD	150	32	182	51	12,2	120	
367h 29K200r ZLD	200	32	234	61	12,2	120	

Technische Beschreibung

- Stahlblechgehäuse
- verzinkt-passiviert
- Schwenklager mit zweireihigem Kugellauf
- staub- und spritzwassergeschützt durch Kunststoff-Dichtring
- auch mit Platte PD (77x67 mm) und Rückenloch LC (10,2 mm) lieferbar

Radserie 29Kr

- thermoplastische Elastomer-Bandage (TPE) eisengrau RAL 7011 (Shore A 80)
- Kunststoff-Radkörper und Kunststoff-Fadenschutz silbergrau RAL 7001
- Präzisionskugellager
- Kontaktverfärbung auf unversiegelten Böden möglich!

Technical description

- sheet steel metal housing
- zinc passivated
- swivel bearing with double ball race
- protected from dust and water spray with plastic seal
- also available with plate PD (77x67 mm)
- also available with bolt hole LC (10,2 mm)















Wheel series 29Kr

- thermoplastic elastomer tyre (TPE) iron grey RAL 7011 (Shore A 80)
- plastic wheel centre and thread guard silver grey RAL7001
- precision ball bearing
- Contact discoloration on unsealed grounds possible!

367a Lenkrolle / Swivel castor

367h Lenkrolle mit Totalfeststeller nachlaufend / Swivel castor with total brake mounted behind



							
367a 29K080r Z522	80	30	112	43,5	24x45 M8/19	100	
367a 29K100r Z522	100	30	133	41,5	24x45 M8/19	100	
367a 29K125r Z522	125	32	157,5	43,5	24x45 M8/19	100	
367a 29K150r Z522	150	32	184	51	24x45 M8/19	120	
367a 29K200r Z522	200	32	236	61	24x45 M8/19	120	
							
367h 29K080r Z522	80	30	112	43,5	24x45 M8/19	100	
367h 29K100r Z522	100	30	133	41,5	24x45 M8/19	100	
367h 29K125r Z522	125	32	157,5	43,5	24x45 M8/19	100	
367h 29K150r Z522	150	32	184	51	24x45 M8/19	120	
367h 29K200r Z522	200	32	236	61,01	24x45 M8/19	120	

Technische Beschreibung

- Stahlblechgehäuse
- verzinkt-passiviert
- Schwenklager mit zweireihigem Kugellauf
- staub- und spritzwassergeschützt durch Kunststoff-Dichtring
- auch mit Platte PD (77x67 mm) und Rückenloch LC (10,2 mm) lieferbar
- auf Anfrage auch verfügbar mit Zapfen Z622 (28x45 mm)
- Befestigung siehe Kapitel »Zubehör«

Radserie 29Kr

- thermoplastische Elastomer-Bandage (TPE) eisengrau RAL 7011 (Shore A 80)
- Kunststoff-Radkörper und Kunststoff-Fadenschutz silbergrau RAL 7001
- Präzisionskugellager
- Kontaktverfärbung auf unversiegelten Böden möglich!

Technical description

- sheet steel metal housing
- zinc passivated
- swivel bearing with double ball race
- protected from dust and water spray with plastic seal
- also available with plate PD (77x67 mm)
- also available with bolt hole LC (10,2 mm)
- on inquiry also available with fixing stem Z622 (28x45 mm)
- attachment see chapter »Accessories«

Wheel series 29Kr

- thermoplastic elastomer tyre (TPE) iron grey RAL 7011 (Shore A 80)
- plastic wheel centre and thread guard silver grey RAL7001
- precision ball bearing
- Contact discoloration on unsealed grounds possible!

367a Lenkrolle / Swivel castor

367h Lenkrolle mit Totalfeststeller nachlaufend / Swivel castor with total brake mounted behind



367a 29K080r ZR	80	30	111	43,5	100	
367a 29K100r ZR	100	30	132	41,5	100	
367a 29K125r ZR	125	32	156,5	43,5	100	
367a 29K150r ZR	150	32	183	51	120	
367a 29K200r ZR	200	32	235	61	120	
367h 29K080r ZR	80	30	111	43,5	100	
367h 29K100r ZR	100	30	132	41,5	100	
367h 29K125r ZR	125	32	156,5	43,5	100	
367h 29K150r ZR	150	32	183	51	120	
367h 29K200r ZR	200	32	235	61	120	

Technische Beschreibung

- Stahlblechgehäuse
- verzinkt-passiviert
- Schwenklager mit zweireihigem Kugellauf
- staub- und spritzwassergeschützt durch Kunststoff-Dichtring
- auch mit Platte PD (77x67 mm) und Rückenloch LC (10,2 mm) lieferbar
- Befestigung siehe Kapitel »Zubehör«

Radserie 29Kr

- thermoplastische Elastomer-Bandage (TPE) eisengrau RAL 7011 (Shore A 80)
- Kunststoff-Radkörper und Kunststoff-Fadenschutz silbergrau RAL 7001
- Präzisionskugellager
- Kontaktverfärbung auf unversiegelten Böden möglich!

Technical description

- sheet steel metal housing
- zinc passivated
- swivel bearing with double ball race
- protected from dust and water spray with plastic seal
- also available with plate PD (77x67 mm)
- also available with bolt hole LC (10,2 mm)
- attachment see chapter »Accessories«

Wheel series 29Kr

- thermoplastic elastomer tyre (TPE) iron grey RAL 7011 (Shore A 80)
- plastic wheel centre and thread guard silver grey RAL7001
- precision ball bearing
- Contact discoloration on unsealed grounds possible!

367a Lenkrolle / Swivel castor

367h Lenkrolle mit Totalfeststeller nachlaufend / Swivel castor with total brake mounted behind

364a Bockrolle / Fixed castor



367a 29G100r ZPF	100	30	138	41,5	95x70	9	75x45/72x52	100	
367a 29G125r ZPF	125	30	162,5	43,5	95x70	9	75x45/72x52	100	



367h 29G100r ZPF	100	30	138	41,5	95x70	9	75x45/72x52	100	
367h 29G125r ZPF	125	30	162,5	43,5	95x70	9	75x45/72x52	100	



364a 29G100r ZPF	100	30	138		95x70	9	75x45/72x52	100	
364a 29G125r ZPF	125	30	162,5		95x70	9	75x45/72x52	100	

Technische Beschreibung

- Stahlblechgehäuse
- verzinkt-passiviert
- Schwenklager mit zweireihigem Kugellauf
- staub- und spritzwassergeschützt durch Kunststoff-Dichtring
- auch mit Platte PD (77x67 mm) und Rückenloch LC (10,2 mm) lieferbar

Radserie 29Gr

- thermoplastische Elastomer-Bandage (TPE), eisengrau RAL 7011 (Shore A 80)
- Kunststoff-Radkörper silbergrau RAL 7001 ohne Fadenschutz
- Gleitlager
- Kontaktverfärbung auf unversiegelten Böden möglich!

Technical description

- sheet steel metal housing
- zinc passivated
- swivel bearing with double ball race
- protected from dust and water spray with plastic seal
- also available with plate PD (77x67 mm)
- also available with bolt hole LC (10,2 mm)

Wheel series 29Gr

- thermoplastic elastomer tyre (TPE) iron grey RAL 7011 (Shore A 80)
- plastic wheel centre silver grey RAL7001
- without thread guard
- plain bearing
- Contact discoloration on unsealed grounds possible!

367a Lenkrolle / Swivel castor

367h Lenkrolle mit Totalfeststeller nachlaufend / Swivel castor with total brake mounted behind

Möbelrollen
Furniture castors

Apparaterollen
Apparatus castors

Medizinisch-Technische Rollen
Medical equipment castors

Transportgeräterollen
Transport appliance castors

Edelstahlrollen
Stainless steel castors

Schwerlastrollen
Heavy duty castors

Bäckerrollen
Bakery castors

Räder
Wheels

Zubehör
Accessories



367a 29G100r ZLD	100	30	131	41,5	12,2	100		
367a 29G125r ZLD	125	30	155,5	43,5	12,2	100		



367h 29G100r ZLD	100	30	131	41,5	12,2	100		
367h 29G125r ZLD	125	30	155,5	43,5	12,2	100		



367a 29G100r Z522	100	30	133	41,5	24x45 M8/19	100		
367a 29G125r Z522	125	30	157,5	43,5	24x45 M8/19	100		



367h 29G100r Z522	100	30	133	41,5	24x45 M8/19	100		
367h 29G125r Z522	125	30	157,5	43,5	24x45 M8/19	100		

Technische Beschreibung

- Stahlblechgehäuse
- verzinkt-passiviert
- Schwenklager mit zweireihigem Kugellauf
- staub- und spritzwassergeschützt durch Kunststoff-Dichtring
- auch mit Platte PD (77x67 mm) und Rückenloch LC (10,2 mm) lieferbar

Radserie 29Gr

- thermoplastische Elastomer-Bandage (TPE), eisengrau RAL 7011 (Shore A 80)
- Kunststoff-Radkörper silbergrau RAL 7001 ohne Fadenschutz
- Gleitlager
- Kontaktverfärbung auf unversiegelten Böden möglich!

Technical description

- sheet steel metal housing
- zinc passivated
- swivel bearing with double ball race
- protected from dust and water spray with plastic seal
- also available with plate PD (77x67 mm)
- also available with bolt hole LC (10,2 mm)







Wheel series 29Gr

- thermoplastic elastomer tyre (TPE) iron grey RAL 7011 (Shore A 80)
- plastic wheel centre silver grey RAL7001
- without thread guard
- plain bearing
- Contact discoloration on unsealed grounds possible!







367a Lenkrolle / Swivel castor

367h Lenkrolle mit Totalfeststeller nachlaufend / Swivel castor with total brake mounted behind



						
367a 29G100r ZR	100	30	132	41,5	100	
367a 29G125r ZR	125	30	156,5	43,5	100	



						
367h 29G100r ZR	100	30	132	41,5	100	
367h 29G125r ZR	125	30	156,5	43,5	100	

Technische Beschreibung

- Stahlblechgehäuse
- verzinkt-passiviert
- Schwenklager mit zweireihigem Kugellauf
- staub- und spritzwassergeschützt durch Kunststoff-Dichtring
- auch mit Platte PD (77x67 mm) und Rückenloch LC (10,2 mm) lieferbar
- Befestigung siehe Kapitel »Zubehör«

Radserie 29Gr

- thermoplastische Elastomer-Bandage (TPE), eisengrau RAL 7011 (Shore A 80)
- Kunststoff-Radkörper silbergrau RAL 7001 ohne Fadenschutz
- Gleitlager
- Kontaktverfärbung auf unversiegelten Böden möglich!

Technical description

- sheet steel metal housing
- zinc passivated
- swivel bearing with double ball race
- protected from dust and water spray with plastic seal
- also available with plate PD (77x67 mm)
- also available with bolt hole LC (10,2 mm)
- attachment see chapter »Accessories«

Wheel series 29Gr

- thermoplastic elastomer tyre (TPE) iron grey RAL 7011 (Shore A 80)
- plastic wheel centre silver grey RAL7001
- without thread guard
- plain bearing
- Contact discoloration on unsealed grounds possible!

367a Lenkrolle / Swivel castor

367h Lenkrolle mit Totalfeststeller nachlaufend / Swivel castor with total brake mounted behind

364a Bockrolle / Fixed castor

Möbelrollen
Furniture castors

Apparaterollen
Apparatus castors

Medizinisch-Technische Rollen
Medical equipment castors

Transportgeräterollen
Transport appliance castors

Edelstahlrollen
Stainless steel castors

Schwerlastrollen
Heavy duty castors

Bäckerrollen
Bakery castors

Räder
Wheels

Zubehör
Accessories



367a 32C080b ZPF	80	30	117	43,5	95x70	9	75x45/72x52	80	
367a 32C100b ZPF	100	32	138	41,5	95x70	9	75x45/72x52	80	
367a 32C125b ZPF	125	32	162,5	43,5	95x70	9	75x45/72x52	100	
367a 32C150b ZPF	150	32	189	51	95x70	9	75x45/72x52	110	
367a 32C200b ZPF	200	32	241	61	95x70	9	75x45/72x52	120	
367h 32C080b ZPF	80	30	117	43,5	95x70	9	75x45/72x52	80	
367h 32C100b ZPF	100	32	138	41,5	95x70	9	75x45/72x52	80	
367h 32C125b ZPF	125	32	162,5	43,5	95x70	9	75x45/72x52	100	
367h 32C150b ZPF	150	32	189	51	95x70	9	75x45/72x52	110	
367h 32C200b ZPF	200	32	241	61	95x70	9	75x45/72x52	110	
364a 32C080b ZPF	80	30	117		95x70	9	75x45/72x52	80	
364a 32C100b ZPF	100	32	138		95x70	9	75x45/72x52	80	
364a 32C125b ZPF	125	32	162,5		95x70	9	75x45/72x52	100	
364a 32C150b ZPF	150	32	189		95x70	9	75x45/72x52	110	
364a 32C200b ZPF	200	32	241		95x70	9	75x45/72x52	120	

Technische Beschreibung

- Stahlblechgehäuse
- verzinkt-passiviert
- Schwenklager mit zweireihigem Kugellauf
- staub- und spritzwassergeschützt durch Kunststoff-Dichtring
- auch mit Platte PD (77x67 mm) und Rückenloch LC (10,2 mm) lieferbar

Radserie 32Cb

- Vollgummireifen blaugrau (Shore A 80)
- Stahlblechfelge und Metall-Fadenschutz verzinkt-passiviert
- Flanschlager

Technical description

- sheet steel metal housing
- zinc passivated
- swivel bearing with double ball race
- protected from dust and water spray with plastic seal
- also available with plate PD (77x67 mm)
- also available with bolt hole LC (10,2 mm)















Wheel series 32Cb

- solid rubber tyre blue-grey (Shore A 80)
- sheet steel metal rim zinc passivated
- metal thread guard
- flange bearing

367a Lenkrolle / Swivel castor

367h Lenkrolle mit Totalfeststeller nachlaufend / Swivel castor with total brake mounted behind



							
367a 32C080b ZLD	80	30	110	43,5	12,2	80	
367a 32C100b ZLD	100	30	131	41,5	12,2	80	
367a 32C125b ZLD	125	32	155,5	43,5	12,2	100	
367a 32C150b ZLD	150	32	182	51	12,2	110	
367a 32C200b ZLD	200	32	234	61	12,2	120	
							
367h 32C080b ZLD	80	30	110	43,5	12,2	80	
367h 32C100b ZLD	100	30	131	41,5	12,2	80	
367h 32C125b ZLD	125	32	155,5	43,5	12,2	100	
367h 32C150b ZLD	150	32	182	51	12,2	110	
367h 32C200b ZLD	200	32	234	61	12,2	120	

Technische Beschreibung

- Stahlblechgehäuse
- verzinkt-passiviert
- Schwenklager mit zweireihigem Kugellauf
- staub- und spritzwassergeschützt durch Kunststoff-Dichtring
- auch mit Platte PD (77x67 mm) und Rückenloch LC (10,2 mm) lieferbar

Radserie 32Cb

- Vollgummireifen blaugrau (Shore A 80)
- Stahlblechfelge und Metall-Fadenschutz verzinkt-passiviert
- Flanschlager

Technical description

- sheet steel metal housing
- zinc passivated
- swivel bearing with double ball race
- protected from dust and water spray with plastic seal
- also available with plate PD (77x67 mm)
- also available with bolt hole LC (10,2 mm)

Wheel series 32Cb

- solid rubber tyre blue-grey (Shore A 80)
- sheet steel metal rim zinc passivated
- metal thread guard
- flange bearing

367a Lenkrolle / Swivel castor

367h Lenkrolle mit Totalfeststeller nachlaufend / Swivel castor with total brake mounted behind

Möbelrollen
Furniture castors

Apparaterollen
Apparatus castors

Medizinisch-Technische Rollen
Medical equipment castors

Transportgeräterollen
Transport appliance castors

Edelstahlrollen
Stainless steel castors

Schwerlastrollen
Heavy duty castors

Bäckerrollen
Bakery castors

Räder
Wheels

Zubehör
Accessories



367a 32C080b Z522	80	30	112	43,5	24x45 M8/19	80	
367a 32C100b Z522	100	30	133	41,5	24x45 M8/19	80	
367a 32C125b Z522	125	32	157,5	43,5	24x45 M8/19	100	
367a 32C150b Z522	150	32	184	51	24x45 M8/19	110	
367a 32C200b Z522	200	32	236	61	24x45 M8/19	120	
367h 32C080b Z522	80	30	112	43,5	24x45 M8/19	80	
367h 32C100b Z522	100	30	133	41,5	24x45 M8/19	80	
367h 32C125b Z522	125	32	157,5	43,5	24x45 M8/19	100	
367h 32C150b Z522	150	32	184	51	24x45 M8/19	110	
367h 32C200b Z522	200	32	236	61	24x45 M8/19	120	

Technische Beschreibung

- Stahlblechgehäuse
- verzinkt-passiviert
- Schwenklager mit zweireihigem Kugellauf
- staub- und spritzwassergeschützt durch Kunststoff-Dichtring
- auch mit Platte PD (77x67 mm) und Rückenloch LC (10,2 mm) lieferbar
- auf Anfrage auch verfügbar mit Zapfen Z622 (28x45 mm)
- Befestigung siehe Kapitel »Zubehör«

Radserie 32Cb

- Vollgummireifen blaugrau (Shore A 80)
- Stahlblechfelge und Metall-Fadenschutz verzinkt-passiviert
- Flanschlager

Technical description

- sheet steel metal housing
- zinc passivated
- swivel bearing with double ball race
- protected from dust and water spray with plastic seal
- also available with plate PD (77x67 mm)
- also available with bolt hole LC (10,2 mm)
- on inquiry also available with fixing stem Z622 (28x45 mm)
- attachment see chapter »Accessories«













Wheel series 32Cb

- solid rubber tyre blue-grey (Shore A 80)
- sheet steel metal rim zinc passivated
- metal thread guard
- flange bearing

367a Lenkrolle / Swivel castor

367h Lenkrolle mit Totalfeststeller nachlaufend / Swivel castor with total brake mounted behind



						
367a 32C080b ZR	80	30	111	43,5	80	
367a 32C100b ZR	100	30	132	41,5	80	
367a 32C125b ZR	125	32	156,5	43,5	100	
367a 32C150b ZR	150	32	183	51	110	
367a 32C200b ZR	200	32	235	61	120	
						
367h 32C080b ZR	80	30	111	43,5	80	
367h 32C100b ZR	100	30	132	41,5	80	
367h 32C125b ZR	125	32	156,5	43,5	100	
367h 32C150b ZR	150	32	183	51	110	
367h 32C200b ZR	200	32	235	61	120	

Technische Beschreibung

- Stahlblechgehäuse
- verzinkt-passiviert
- Schwenklager mit zweireihigem Kugellauf
- staub- und spritzwassergeschützt durch Kunststoff-Dichtring
- auch mit Platte PD (77x67 mm) und Rückenloch LC (10,2 mm) lieferbar
- Befestigung siehe Kapitel »Zubehör«

Radserie 32Cb

- Vollgummireifen blaugrau (Shore A 80)
- Stahlblechfelge und Metall-Fadenschutz verzinkt-passiviert
- Flanschlager

Technical description

- sheet steel metal housing
- zinc passivated
- swivel bearing with double ball race
- protected from dust and water spray with plastic seal
- also available with plate PD (77x67 mm)
- also available with bolt hole LC (10,2 mm)
- attachment see chapter »Accessories«

Wheel series 32Cb

- solid rubber tyre blue-grey (Shore A 80)
- sheet steel metal rim zinc passivated
- metal thread guard
- flange bearing

Medizinisch- Technische Rollen Medical equipment castors

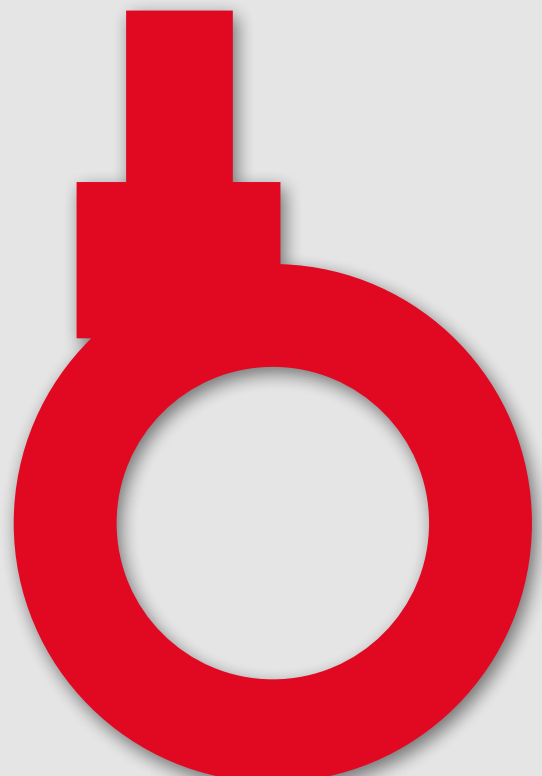

390q Lenkrolle, zentral- und totalfeststellbar / Swivel castor with central total brake

390r Lenkrolle zentral-, total- und richtungsfeststellbar / Swivel castor with central/directional total brake

Michelrollen
Furniture castors

Apparaterollen
Apparatus castors

Medizinisch-Technische Rollen
Medical equipment castors

Transportgeräterollen
Transport appliance castors

Edelstahlrollen
Stainless steel castors

Schwerlastrollen
Heavy duty castors

Bäckerrollen
Bakery castors

Räder
Wheels

Zubehör
Accessories



390q 29K080r Z2351	80	30	113	44	80	•
390r 29K080r Z2351	80	30	113	44	80	•
390q 29K100r Z2351	100	30	133	42	100	•
390r 29K100r Z2351	100	30	133	42	100	•
390q 29K125r Z2351	125	32	158	44	100	
390r 29K125r Z2351	125	32	158	44	100	
390q 29K150r Z2351	150	32	184	51	120	
390r 29K150r Z2351	150	32	184	51	120	
390q 29K200r Z2351	200	32	237	61	120	
390r 29K200r Z2351	200	32	237	61	120	
390q 29K080r Z985	80	30	113	44	80	•
390r 29K080r Z985	80	30	113	44	80	•
390q 29K100r Z985	100	30	133	42	100	•
390r 29K100r Z985	100	30	133	42	100	•
390q 29K125r Z985	125	32	158	44	100	
390r 29K125r Z985	125	32	158	44	100	
390q 29K150r Z985	150	32	184	51	120	
390r 29K150r Z985	150	32	184	51	120	
390q 29K200r Z985	200	32	237	61	120	
390r 29K200r Z985	200	32	237	61	120	

• Artikel auf Anfrage / product on request

Technische Beschreibung

- Stahlblechgehäuse verzinkt-passiviert
- Schwenklager mit zweireihigem Kugellauf
- geeignet zur Reinigung in Desinfektionskabinen
- staub- und spritzwassergeschützt
- integrierte Schaltmechanik mit Totalfeststeller "q" und zusätzlichem Richtungsfeststeller "r"
- Dauerfettfüllung in der Schaltmechanik
- Festlegung des Befestigungsaufbaus, Hülsen zur Adaptierung in Rund- und Vierkantrohren, sowie Tritt- und Mitnehmerhebel siehe Seite 98–102

Radserie 29Kr

- thermoplastische Elastomer-Bandage (TPE) eisengrau RAL 7011 (Shore A 80)
- Kunststoff-Radkörper und Kunststoff-Fadenschutz silbergrau RAL 7001
- Präzisionskugellager
- Kontaktverfärbung auf unversiegelten Böden möglich!
- auch mit anderen Radvarianten lieferbar, siehe Kapitel »Räder«

Technical description

- sheet steel metal housing
- zinc passivated
- double ball bearing in swivel head
- protected from dust and water ingress by plastic sealing ring
- integrated selection mechanism with total lock "q" and directional locking "r"
- selection mechanism continually greased
- Guideline for finding the correct structure of attachment, foot and transmission lever, see on page 98–102

Wheel series 29Kr

- thermoplastic elastomer tyre (TPE) iron grey RAL 7011 (Shore A 80)
- plastic wheel centre and thread guard silver grey RAL7001
- precision ball bearing
- Contact discoloration on unsealed grounds possible!
- also available with other wheel variants, see chapter »Wheels«

390q Lenkrolle, zentral- und totalfeststellbar / Swivel castor with central total brake

390r Lenkrolle zentral-, total- und richtungsfeststellbar / Swivel castor with central/directional total brake



390q 32C080b Z2351	80	30	113	44	80	•
390r 32C080b Z2351	80	30	113	44	80	•
390q 32C100b Z2351	100	32	133	42	80	•
390r 32C100b Z2351	100	32	133	42	80	•
390q 32C125b Z2351	125	32	158	44	100	
390r 32C125b Z2351	125	32	158	44	100	
390q 32C150b Z2351	150	32	184	51	110	
390r 32C150b Z2351	150	32	184	51	110	
390q 32C200b Z2351	200	32	237	61	120	
390r 32C200b Z2351	200	32	237	61	120	



390q 32C080b Z985	80	30	113	44	80	•
390r 32C080b Z985	80	30	113	44	80	•
390q 32C100b Z985	100	32	133	42	80	•
390r 32C100b Z985	100	32	133	42	80	•
390q 32C125b Z985	125	32	158	44	100	
390r 32C125b Z985	125	32	158	44	100	
390q 32C150b Z985	150	32	184	51	110	
390r 32C150b Z985	150	32	184	51	110	
390q 32C200b Z985	200	32	237	61	120	
390r 32C200b Z985	200	32	237	61	120	

• Artikel auf Anfrage / product on request

Technische Beschreibung

- Stahlblechgehäuse verzinkt-passiviert
- Schwenklager mit zweireihigem Kugellauf
- geeignet zur Reinigung in Desinfektionskabinen
- staub- und spritzwassergeschützt
- integrierte Schaltmechanik mit Totalfeststeller "q" und zusätzlichem Richtungsfeststeller "r"
- Dauerfettfüllung in der Schaltmechanik
- Festlegung des Befestigungsaufbaus, Hülsen zur Adaptierung in Rund- und Vierkantrohren, sowie Tritt- und Mitnehmerhebel siehe Seite 98–102

Radserie 32Cb

- Vollgummireifen blaugrau (Shore A 80)
- Stahlblechfelge und Metall-Fadenschutz verzinkt-passiviert
- Flanschlager
- auch mit anderen Radvarianten lieferbar, siehe Kapitel »Räder«

Technical description

- sheet steel metal housing
- zinc passivated
- double ball bearing in swivel head
- protected from dust and water ingress by plastic sealing ring
- integrated selection mechanism with total lock "q" and directional locking "r"
- selection mechanism continually greased
- Guideline for finding the correct structure of attachment, foot and transmission lever, see on page 98–102

Wheel series 32Cb

- solid rubber tyre blue-grey (Shore A 80)
- sheet steel metal rim zinc passivated
- metal thread guard
- flange bearing
- also available with other wheel variants, see chapter »Wheels«

390q Lenkrolle, zentral- und totalfeststellbar / Swivel castor with central total brake

390r Lenkrolle zentral-, total- und richtungsfeststellbar / Swivel castor with central/directional total brake



390q 29K100r Z2351 C	100	30	133	42	100	•
390r 29K100r Z2351 C	100	30	133	42	100	•
390q 29K125r Z2351 C	125	32	158	44	100	
390r 29K125r Z2351 C	125	32	158	44	100	
390q 29K150r Z2351 C	150	32	184	51	120	
390r 29K150r Z2351 C	150	32	184	51	120	
390q 29K200r Z2351 C	200	32	237	61	120	
390r 29K200r Z2351 C	200	32	237	61	120	
390q 29K100r Z985 C	100	30	133	42	100	•
390r 29K100r Z985 C	100	30	133	42	100	•
390q 29K125r Z985 C	125	32	158	44	100	
390r 29K125r Z985 C	125	32	158	44	100	
390q 29K150r Z985 C	150	32	184	51	120	
390r 29K150r Z985 C	150	32	184	51	120	
390q 29K200r Z985 C	200	32	237	61	120	
390r 29K200r Z985 C	200	32	237	61	120	

• Artikel auf Anfrage / product on request

Technische Beschreibung

- Stahlblechgehäuseverzinkt-passiviert
- modernes Design durch hochwertiges Kunststoff-Cover
- Schwenklager mit zweireihigem Kugellauf
- geeignet zur Reinigung in Desinfektionskabinen
- staub- und spritzwassergeschützt
- integrierte Schaltmechanik mit Totalfeststeller "q" und zusätzlichem Richtungsfeststeller "r"
- Dauerfettfüllung in der Schaltmechanik
- Festlegung des Befestigungsaufbaus, Hülsen zur Adaptierung in Rund- und Vierkantrohren, sowie Tritt- und Mitnehmerhebel siehe Seite 98–102

Radserie 29Kr

- thermoplastische Elastomer-Bandage (TPE) eisengrau RAL 7011 (Shore A 80)
- Kunststoff-Radkörper und Kunststoff-Fadenschutz silbergrau RAL 7001
- Präzisionskugellager
- Kontaktverfärbung auf unversiegelten Böden möglich!
- auch mit anderen Radvarianten lieferbar, siehe Kapitel »Räder«

Technical description

- sheet steel metal housing
- zinc passivated
- modern desing with high-quality plastic cover
- double ball bearing in swivel head
- protected from dust and water ingress by plastic sealing ring
- integrated selection mechanism with total lock "q" and directional locking "r"
- selection mechanism continually greased
- Guideline for finding the correct structure of attachment, foot and transmission lever, see on page 98–102

Wheel series 29Kr

- thermoplastic elastomer tyre (TPE) iron grey RAL 7011 (Shore A 80)
- plastic wheel centre and thread guard silver grey RAL7001
- precision ball bearing
- Contact discoloration on unsealed grounds possible!
- also available with other wheel variants, see chapter »Wheels«

Möbelrollen Furniture castors
 Apparaterollen Apparatus castors
Medizinisch-Technische Rollen Medical equipment castors
 Transportgeräterollen Transport appliance castors
 Edelstahlrollen Stainless steel castors
 Schwerlastrollen Heavy duty castors
 Backenrollen Bakery castors
 Räder Wheels
 Zubehör Accessories

390q Lenkrolle, zentral- und totalfeststellbar / Swivel castor with central total brake

390r Lenkrolle zentral-, total- und richtungsfeststellbar / Swivel castor with central/directional total brake



390q 29K100r Z2351 CA	100	30	133	42	100	•
390r 29K100r Z2351 CA	100	30	133	42	100	•
390q 29K125r Z2351 CA	125	32	158	44	100	
390r 29K125r Z2351 CA	125	32	158	44	100	
390q 29K150r Z2351 CA	150	32	184	51	120	
390r 29K150r Z2351 CA	150	32	184	51	120	
390q 29K200r Z2351 CA	200	32	237	61	120	
390r 29K200r Z2351 CA	200	32	237	61	120	
390q 29K100r Z985 CA	100	30	133	42	100	•
390r 29K100r Z985 CA	100	30	133	42	100	•
390q 29K125r Z985 CA	125	32	158	44	100	
390r 29K125r Z985 CA	125	32	158	44	100	
390q 29K150r Z985 CA	150	32	184	51	120	
390r 29K150r Z985 CA	150	32	184	51	120	
390q 29K200r Z985 CA	200	32	237	61	120	
390r 29K200r Z985 CA	200	32	237	61	120	

• Artikel auf Anfrage / product on request

Technische Beschreibung

- Stahlblechgehäuseverzinkt-passiviert
- modernes Design durch hochwertiges Kunststoff-Cover
- Schwenklager mit zweireihigem Kugellauf
- geeignet zur Reinigung in Desinfektionskabinen
- staub- und spritzwassergeschützt
- integrierte Schaltmechanik mit Totalfeststeller "q" und zusätzlichem Richtungsfeststeller "r"
- Dauerfettfüllung in der Schaltmechanik
- Festlegung des Befestigungsaufbaus, Hülsen zur Adaptierung in Rund- und Vierkantrohren, sowie Tritt- und Mitnehmerhebel siehe Seite 98–102

Radserie 29Kr

- thermoplastische Elastomer-Bandage (TPE) eisengrau RAL 7011 (Shore A 80)
- Kunststoff-Radkörper und Kunststoff-Fadenschutz silbergrau RAL 7001
- Präzisionskugellager
- Kontaktverfärbung auf unversiegelten Böden möglich!
- auch mit anderen Radvarianten lieferbar, siehe Kapitel »Räder«

Technical description

- sheet steel metal housing
- zinc passivated
- modern design with high-quality plastic cover
- double ball bearing in swivel head
- protected from dust and water ingress by plastic sealing ring
- integrated selection mechanism with total lock "q" and directional locking "r"
- selection mechanism continually greased
- Guideline for finding the correct structure of attachment, foot and transmission lever, see on page 98–102

Wheel series 29Kr

- thermoplastic elastomer tyre (TPE) iron grey RAL 7011 (Shore A 80)
- plastic wheel centre and thread guard silver grey RAL7001
- precision ball bearing
- Contact discoloration on unsealed grounds possible!
- also available with other wheel variants, see chapter »Wheels«

390q Lenkrolle, zentral- und totalfeststellbar / Swivel castor with central total brake

390r Lenkrolle zentral-, total- und richtungsfeststellbar / Swivel castor with central/directional total brake



390q 32C125b Z2351 C	125	32	158	44	100	
390r 32C125b Z2351 C	125	32	158	44	100	
390q 32C150b Z2351 C	150	32	184	51	110	
390r 32C150b Z2351 C	150	32	184	51	110	
390q 32C200b Z2351 C	200	32	237	61	120	
390r 32C200b Z2351 C	200	32	237	61	120	
390q 32C125b Z985 C	125	32	158	44	100	
390r 32C125b Z985 C	125	32	158	44	100	
390q 32C150b Z985 C	150	32	184	51	110	
390r 32C150b Z985 C	150	32	184	51	110	
390q 32C200b Z985 C	200	32	237	61	120	
390r 32C200b Z985 C	200	32	237	61	120	

Möbelrollen
Furniture castors

Apparaterollen
Apparatus castors

Medizinisch-Technische Rollen
Medical equipment castors

Transportgeräterollen
Transport appliance castors

Edelstahlrollen
Stainless steel castors

Schwerlastrollen
Heavy duty castors

Bäckereierollen
Bakery castors

Räder
Wheels

Zubehör
Accessories

Technische Beschreibung

- Stahlblechgehäuseverzinkt-passiviert
- modernes Design durch hochwertiges Kunststoff-Cover
- Schwenklager mit zweireihigem Kugellauf
- geeignet zur Reinigung in Desinfektionskabinen
- staub- und spritzwassergeschützt
- integrierte Schaltmechanik mit Totalfeststeller "q" und zusätzlichem Richtungsfeststeller "r"
- Dauerfettfüllung in der Schaltmechanik
- Festlegung des Befestigungsaufbaus, Hülsen zur Adaptierung in Rund- und Vierkantrohren, sowie Tritt- und Mitnehmerhebel siehe Seite 98–102

Radserie 32Cb

- Vollgummireifen blaugrau (Shore A 80)
- Stahlblechfelge und Metall-Fadenschutz verzinkt-passiviert
- Flanschlager
- auch mit anderen Radvarianten lieferbar, siehe Kapitel »Räder«

Technical description

- sheet steel metal housing
- zinc passivated
- modern desing with high-quality plastic cover
- double ball bearing in swivel head
- protected from dust and water ingress by plastic sealing ring
- integrated selection mechanism with total lock "q" and directional locking "r"
- selection mechanism continually greased
- Guideline for finding the correct structure of attachment, foot and transmission lever, see on page 98–102

Wheel series 32Cb

- solid rubber tyre blue-grey (Shore A 80)
- sheet steel metal rim zinc passivated
- metal thread guard
- flange bearing
- also available with other wheel variants, see chapter »Wheels«

390q Lenkrolle, zentral- und totalfeststellbar / Swivel castor with central total brake

390r Lenkrolle zentral-, total- und richtungsfeststellbar / Swivel castor with central/directional total brake



390q 32C125b Z2351 CA	125	32	158	44	100	
390r 32C125b Z2351 CA	125	32	158	44	100	
390q 32C150b Z2351 CA	150	32	184	51	110	
390r 32C150b Z2351 CA	150	32	184	51	110	
390q 32C200b Z2351 CA	200	32	237	61	120	
390r 32C200b Z2351 CA	200	32	237	61	120	

390q 32C125b Z985 CA	125	32	158	44	100	
390r 32C125b Z985 CA	125	32	158	44	100	
390q 32C150b Z985 CA	150	32	184	51	110	
390r 32C150b Z985 CA	150	32	184	51	110	
390q 32C200b Z985 CA	200	32	237	61	120	
390r 32C200b Z985 CA	200	32	237	61	120	

Technische Beschreibung

- Stahlblechgehäuseverzinkt-passiviert
- modernes Design durch hochwertiges Kunststoff-Cover
- Schwenklager mit zweireihigem Kugellauf
- geeignet zur Reinigung in Desinfektionskabinen
- staub- und spritzwassergeschützt
- integrierte Schaltmechanik mit Totalfeststeller "q" und zusätzlichem Richtungsfeststeller "r"
- Dauerfettfüllung in der Schaltmechanik
- Festlegung des Befestigungsaufbaus, Hülsen zur Adaptierung in Rund- und Vierkantrohren, sowie Tritt- und Mitnehmerhebel siehe Seite 98–102

Radserie 32Cb

- Vollgummireifen blaugrau (Shore A 80)
- Stahlblechfelge und Metall-Fadenschutz verzinkt-passiviert
- Flanschlager
- auch mit anderen Radvarianten lieferbar, siehe Kapitel »Räder«

Technical description

- sheet steel metal housing
- zinc passivated
- modern desing with high-quality plastic cover
- double ball bearing in swivel head
- protected from dust and water ingress by plastic sealing ring
- integrated selection mechanism with total lock "q" and directional locking "r"
- selection mechanism continually greased
- Guideline for finding the correct structure of attachment, foot and transmission lever, see on page 98–102

Wheel series 32Cb

- solid rubber tyre blue-grey (Shore A 80)
- sheet steel metal rim zinc passivated
- metal thread quard
- flange bearing
- also available with other wheel variants, see chapter »Wheels«

391q Lenkrolle, zentral- und totalfeststellbar / Swivel castor with central total brake

391r Lenkrolle zentral-, total- und richtungsfeststellbar / Swivel castor with central/directional total brake

Möbelrollen
Furniture castors

Apparaterollen
Apparatus castors

Medizinisch-Technische Rollen
Medical equipment castors

Transportgeräterollen
Transport appliance castors

Edelstahlrollen
Stainless steel castors

Schwerlastrollen
Heavy duty castors

Bäckerrollen
Bakery castors

Räder
Wheels

Zubehör
Accessories



391q 29K100r Z2351	100	30	139	42	100	
391r 29K100r Z2351	100	30	139	42	100	
391q 29K125r Z2351	125	32	164	44	100	
391r 29K125r Z2351	125	32	164	44	100	
391q 29K150r Z2351	150	32	191	51	120	
391r 29K150r Z2351	150	32	191	51	120	
391q 29K200r Z2351	200	32	243	61	120	
391r 29K200r Z2351	200	32	243	61	120	
391q 29K100r Z985	100	30	139	42	100	
391r 29K100r Z985	100	30	139	42	100	
391q 29K125r Z985	125	32	164	44	100	
391r 29K125r Z985	125	32	164	44	100	
391q 29K150r Z985	150	32	191	51	120	
391r 29K150r Z985	150	32	191	51	120	
391q 29K200r Z985	200	32	243	61	120	
391r 29K200r Z985	200	32	243	61	120	

Technische Beschreibung

- Stahlblechgehäuse
- verzinkt-passiviert, alternativ auch in verchromt lieferbar
- Präzisionskugellager im Gabelkopf
- geeignet zur Reinigung in Desinfektionskabinen
- staub- und spritzwassergeschützt
- integrierte Schaltmechanik mit Totalfeststeller "q" und zusätzlichem Richtungsfeststeller "r"
- Dauerfettfüllung in der Schaltmechanik
- Festlegung des Befestigungsaufbaus, Hülsen zur Adaptierung in Rund- und Vierkantrohren, sowie Tritt- und Mitnehmerhebel siehe Seite 98–102

Radserie 29Kr

- thermoplastische Elastomer-Bandage (TPE) eisengrau RAL 7011 (Shore A 80)
- Kunststoff-Radkörper und Kunststoff-Fadenschutz silbergrau RAL 7001
- Präzisionskugellager
- Kontaktverfärbung auf unversiegelten Böden möglich!
- auch mit anderen Radvarianten lieferbar, siehe Kapitel »Räder«

Technical description

- sheet steel metal housing
- zinc passivated
- precision ball bearing in swivel head
- protected from dust and water ingress by plastic sealing ring
- integrated selection mechanism with total lock "q" and directional locking "r"
- selection mechanism continually greased
- Guideline for finding the correct structure of attachment, foot and transmission lever, see on page 98–102







Wheel series 29Kr

- thermoplastic elastomer tyre (TPE) iron grey RAL 7011 (Shore A 80)
- plastic wheel centre and thread guard silver grey RAL7001
- precision ball bearing
- Contact discoloration on unsealed grounds possible!
- also available with other wheel variants, see chapter »Wheels«







391q Lenkrolle, zentral- und totalfeststellbar / Swivel castor with central total brake

391r Lenkrolle zentral-, total- und richtungsfeststellbar / Swivel castor with central/directional total brake



						
391q 32C100b Z2351	100	32	139	42	80	
391r 32C100b Z2351	100	32	139	42	80	
391q 32C125b Z2351	125	32	164	44	100	
391r 32C125b Z2351	125	32	164	44	100	
391q 32C150b Z2351	150	32	191	51	120	
391r 32C150b Z2351	150	32	191	51	120	
391q 32C200b Z2351	200	32	243	61	120	
391r 32C200b Z2351	200	32	243	61	120	



						
391q 32C100b Z985	100	32	139	42	80	
391r 32C100b Z985	100	32	139	42	80	
391q 32C125b Z985	125	32	164	44	100	
391r 32C125b Z985	125	32	164	44	100	
391q 32C150b Z985	150	32	191	51	120	
391r 32C150b Z985	150	32	191	51	120	
391q 32C200b Z985	200	32	243	61	120	
391r 32C200b Z985	200	32	243	61	120	

Technische Beschreibung

- Stahlblechgehäuse
- verzinkt-passiviert, alternativ auch in verchromt lieferbar
- Präzisionskugellager im Gabelkopf
- geeignet zur Reinigung in Desinfektionskabinen
- staub- und spritzwassergeschützt
- integrierte Schaltmechanik mit Totalfeststeller "q" und zusätzlichem Richtungsfeststeller "r"
- Dauerfettfüllung in der Schaltmechanik
- Festlegung des Befestigungsaufbaus, Hülsen zur Adaptierung in Rund- und Vierkantrohren, sowie Tritt- und Mitnehmerhebel siehe Seite 98–102

Radserie 32Cb

- Vollgummireifen blaugrau (Shore A 80)
- Stahlblechfelge und Metall-Fadenschutz verzinkt-passiviert
- Flanschlager
- auch mit anderen Radvarianten lieferbar, siehe Kapitel »Räder«

Technical description

- sheet steel metal housing
- zinc passivated
- precision ball bearing in swivel head
- protected from dust and water ingress by plastic sealing ring
- integrated selection mechanism with total lock "q" and directional locking "r"
- selection mechanism continually greased
- Guideline for finding the correct structure of attachment, foot and transmission lever, see on page 98–102

Wheel series 32Cb

- solid rubber tyre blue-grey (Shore A 80)
- sheet steel metal rim zinc passivated
- metal thread guard
- flange bearing
- also available with other wheel variants, see chapter »Wheels«

PRIMACY

398q Lenkrolle, zentral- und totalfeststellbar / Swivel castor with central total brake

398r Lenkrolle, zentral- und totalfeststellbar / Swivel castor with central total brake

Michelrollen
Furniture castors

Apparaterollen
Apparatus castors

Medizinisch-Technische Rollen
Medical equipment castors

Transportgeräterollen
Transport appliance castors

Edelstahlrollen
Stainless steel castors

Schwerlastrollen
Heavy duty castors

Bäckerrollen
Bakery castors

Räder
Wheels

Zubehör
Accessories



398q 29K100v K2351ZA	100	30	139	38	100	
398r 29K100v K2351ZA	100	30	139	38	100	
398q 29K125v K2351ZA	125	32	158	40	150	
398r 29K125v K2351ZA	125	32	158	40	150	
398q 29K150v K2351ZA	150	32	188	42	150	
398r 29K150v K2351ZA	150	32	188	42	150	
398q 37K200v K2351ZA	200	32	229	56	150	
398r 37K200v K2351ZA	200	32	229	56	150	
398q 29K100v K985NP	100	30	139	38	100	
398r 29K100v K985NP	100	30	139	38	100	
398q 29K125v K985NP	125	32	158	40	150	
398r 29K125v K985NP	125	32	158	40	150	
398q 29K150v K985NP	150	32	188	42	150	
398r 29K150v K985NP	150	32	188	42	150	
398q 37K200v K985NP	200	32	229	56	150	
398r 37K200v K985NP	200	32	229	56	150	

Technische Beschreibung

- tragendes Gehäuse aus Aluminium-Druckguss
- hochglanzpolierte Kunststoff-Abdeckung
- Präzisionskugellager im Gabelkopf
- geeignet zur Reinigung in Desinfektionskabinen
- leichtgängiges Schaltsystem
- integrierte Schaltmechanik mit Totalfeststeller "q" und zusätzlichem Richtungsfeststeller "r"
- Dauerfettfüllung in der Schaltmechanik
- Tragfähigkeit 150 kg
- Festlegung des Befestigungsaufbaus, Hülsen zur Adaptierung in Rund- und Vierkantrohren, sowie Tritt- und Mitnehmerhebel siehe Seite 98–102

Radserie 29Kv

- thermoplastische Polyurethan-Bandage (TPU) eisengrau RAL 7011 (Shore A 95)
- kontaktverfärbungsfrei
- Kunststoff-Radkörper und Kunststoff-Fadenschutz silbergrau RAL 7001
- Präzisionskugellager
- auch mit elektrisch-leitfähigem Rad lieferbar

Technical description

- die-cast aluminium load-bearing housing
- highly polished plastic cover
- precision ball bearings in the fork head
- suitable for cleaning in disinfection cabins
- smooth selection function
- integrated selection mechanism with total locking brake "q" and direction locking brake "r"
- permanently grease filled in the switch mechanism
- load capacity 150 kg
- Guideline for finding the correct structure of attachment, foot and transmission lever, see on page 98–102

Wheel series 29Kv

- thermoplastic polyurethane tyre (TPU) iron grey RAL 7011 (Shore A 95)
- plastic wheel centre and thread guard silver grey RAL7001
- precision ball bearing
- also available with electrically conductive wheel

NIMBUS

399q Lenkrolle, zentral- und totalfeststellbar / Swivel castor with central total brake

399r Lenkrolle zentral-, total- und richtungsfeststellbar / Swivel castor with central/directional total brake

399a Lenkrolle / Swivel castor



399q 38K150v K2351	150	32	188	42	120	
399r 38K150v K2351	150	32	188	42	120	



399q 38K150v K985	150	32	188	42	120	
399r 38K150v K985	150	32	188	42	120	



399a 38K150v KPF-FK	150	32	201	42	95x70	9	75x45/72x52	120

Technische Beschreibung 399q/r

- tragendes Gehäuse aus Aluminium-Druckguss
- hochglanzpolierte Kunststoff-Abdeckung weiß RAL 9016
- einzigartiges Design und patentierte Technik
- Präzisionskugellager im Gabelkopf
- geeignet zur Reinigung in Desinfektionskabinen
- leichtgängiges Schaltsystem
- integrierte Schaltmechanik mit Totalfeststeller "q" und zusätzlichem Richtungsfeststeller "r"
- Dauerfettfüllung in der Schaltmechanik
- Festlegung des Befestigungsaufbaus, Hülsen zur Adaptierung in Rund- und Vierkantrohren, sowie Tritt- und Mitnehmerhebel siehe Seite 98–102

Technische Beschreibung 399a

- tragendes Gehäuse aus Aluminium-Druckguss
- hochglanzpolierte Kunststoff-Abdeckung weiß RAL 9016
- einzigartiges Design und patentierte Technik
- Präzisionskugellager im Gabelkopf

Radserie 38Kv

- TPU-Rad , 64 Shore D, Kugellager

Technical description 399q/r

- die-cast aluminium load-bearing housing
- highly polished plastic cover, optionally in white or metallic
- unique design and patented technology
- precision ball bearings in the fork head
- suitable for cleaning in disinfection cabins
- smooth selection function
- integrated selection mechanism with total locking brake "q" and direction locking brake "r"
- permanently grease filled in the switch mechanism
- Guideline for finding the correct structure of attachment, foot and transmission lever, see on page 98–102

Technical description 399a

- die-cast aluminium load-bearing housing
- highly polished plastic cover white RAL 9016
- unique design and patented technology
- precision ball bearings in the fork head

Wheel series 38Kv

- TPU wheel, 64 Shore D, ball bearing

VIVAX HBC

KH2Q Lenkrolle, zentral- und totalfeststellbar / Swivel castor with central total brake

KH2R Lenkrolle zentral-, total- und richtungsfeststellbar / Swivel castor with central/directional total brake

Möbelrollen
Furniture castors

Apparaterollen
Apparatus castors

Medizinisch-Technische Rollen
Medical equipment castors

Transportgeräterollen
Transport appliance castors

Edelstahlrollen
Stainless steel castors

Schwerlastrollen
Heavy duty castors

Bäckerrollen
Bakery castors

Räder
Wheels

Zubehör
Accessories



KH2Q-51C-Z985-01	125	32	164	46	100	
KH2R-51C-Z985-01	125	32	164	46	100	
KH2Q-61C-Z985-01	150	32	189	46	100	
KH2R-61C-Z985-01	150	32	189	46	100	

KH2Q-51C-Z985-02	125	32	164	46	100	
KH2R-51C-Z985-02	125	32	164	46	100	
KH2Q-61C-Z985-02	150	32	189	46	100	
KH2R-61C-Z985-02	150	32	189	46	100	

Technische Beschreibung

- Gabel aus hochfestem schlagzähem Nylon
- Lenkgabelkopf mit abgedichtetem Rillenkugellager
- Auch mit anderen Radserien lieferbar

Radserie 1C

- Polypropylen-Radkörper mit thermoplastischer Bandage (TPE, Shore A 87, ähnlich RAL 7012)
- Fadenschutz
- Rillenkugellager

Technical description

- Fork made of high-strength impact-resistant nylon
- Swivel fork head with sealed deep groove ball bearing
- Also available with other wheel variants

Wheel series 1C

- Polypropylen wheel center with thermoplastic tyre (TPE, Shore A 87, similar RAL 7012)
- Thread guard
- Deep groove ball bearing

VIVAX EasyFit

VIVAX-KML Lenkrolle / Swivel castor

VIVAX-KMF Lenkrolle mit Radfeststeller / Swivel castor with wheel locking brake



KML-31C-GM10x20	75	25	105	10x20	70	



KMF-31C-GM10x20	75	25	105	10x20	70	

Technische Beschreibung

- Kunststoffrolle
- Gabel aus hochfestem schlagzähem Nylon (RAL 7035)
- Lenkgabelkopf mit abgedichtetem Rillenkugellager
- Auch mit Platte 60x60 und Einschlagbefestigung für 11 mm Bohrung verfügbar

Radserie 1C

- Radserie 1C
- Polypropylen-Radkörper (RAL 7035)
- thermoplastische Bandage (TPE, Shore A 87, RAL 7012)
- Fadenschutz (RAL 7035)
- Rillenkugellager
- Auch mit anderen Radvarianten lieferbar

Technical description

- plastic castor
- fork made of high-strength impact-resistant nylon (similar RAL 7035)
- swivel fork head with sealed deep groove ball bearing
- Also available with plate 60x60 & stem for sockets with bore 11 mm

Wheel series 1C

- wheel series 1C
- polypropylen wheel center (similar RAL 7035)
- thermoplastic tyre (TPE, Shore A 87, similar RAL 7012)
- thread guard (similar RAL 7035)
- deep groove ball bearing
- also available with other wheel variants

VIVAX-KSL VIVAX-KSF

Lenkrolle / Swivel castor

Lenkrolle mit Totalfeststeller nachlaufend / Swivel castor with total brake mounted behind



KSL-31C-P77	75	30	115	41,5	77x66	8,5	61x51/56x46	70
KSL-41C-P77	100	32	140	43	77x66	8,5	61x51/56x46	80
KSL-51C-P77	125	32	168,5	46	77x66	8,5	61x51/56x46	100
KSL-31C-P95	75	30	115	41,5	95x70	8,5	75x50/72x52	70
KSL-41C-P95	100	32	140	43	95x70	8,5	75x50/72x52	80
KSL-51C-P95	125	32	168,5	46	95x70	8,5	75x50/72x52	100
KSL-31C-P100	75	30	115	41,5	100x80	9	80x60/76x55	70
KSL-41C-P100	100	32	140	43	100x80	9	80x60/76x55	80
KSL-51C-P100	125	32	168,5	46	100x80	9	80x60/76x55	100
KSF-31C-P77	75	30	115	41,5	77x66	8,5	61x51/56x46	70
KSF-41C-P77	100	32	140	43	77x66	8,5	61x51/56x46	80
KSF-51C-P77	125	32	168,5	46	77x66	8,5	61x51/56x46	100
KSF-31C-P95	75	30	115	41,5	95x70	8,5	75x50/72x52	70
KSF-41C-P95	100	32	140	43	95x70	8,5	75x50/72x52	80
KSF-51C-P95	125	32	168,5	46	95x70	8,5	75x50/72x52	100
KSF-31C-P100	75	30	115	41,5	100x80	9	80x60/76x55	70
KSF-41C-P100	100	32	140	43	100x80	9	80x60/76x55	80
KSF-51C-P100	125	32	168,5	46	100x80	9	80x60/76x55	100

Technische Beschreibung

- Gabel aus hochfestem schlagzähem Nylon (RAL 7035)
- Lenkgabelkopf mit abgedichtetem Rillenkugellager

Radserie 1C

- Polypropylen-Radkörper (RAL 7035) mit thermoplastischer Bandage (TPE, Shore A 87, RAL 7012)
- Fadenschutz (RAL 7035)
- Rillenkugellager
- auch mit anderen Radvarianten lieferbar

Technical description

- fork made of high-strength impact-resistant nylon (RAL 7035)
- swivel fork head with sealed deep groove ball bearing

Wheel series 1C

- polypropylen wheel center (RAL 7035) with thermoplastic tyre (TPE, Shore A 87, RAL 7012)
- thread guard (RAL 7035)
- deep groove ball bearing
- also available with other wheel variants

Möbelrollen / Furniture castors
 Apparaterollen / Apparatus castors
Medizinisch-Technische Rollen / Medical equipment castors
 Transportgeräterollen / Transport appliance castors
 Edelstahlrollen / Stainless steel castors
 Schwerlastrollen / Heavy duty castors
 Backerrollen / Bakery castors
 Räder / Wheels
 Zubehör / Accessories

VIVAX-KSD

Lenkrolle mit Richtungsfeststeller / Swivel castor with directional lock



KSD-31C-P77	75	30	115	41,5	77x66	8,5	61x51/56x46	70	
KSD-41C-P77	100	32	140	43	77x66	8,5	61x51/56x46	80	
KSD-51C-P77	125	32	168,5	46	77x66	8,5	61x51/56x46	100	
KSD-31C-P95	75	30	115	41,5	95x70	8,5	75x50/72x52	70	
KSD-41C-P95	100	32	140	43	95x70	8,5	75x50/72x52	80	
KSD-51C-P95	125	32	168,5	46	95x70	8,5	75x50/72x52	100	
KSD-31C-P100	75	30	115	41,5	100x80	9	80x60/76x55	70	
KSD-41C-P100	100	32	140	43	100x80	9	80x60/76x55	80	
KSD-51C-P100	125	32	168,5	46	100x80	9	80x60/76x55	100	

Technische Beschreibung

- Gabel aus hochfestem schlagzähem Nylon (RAL 7035)
- Lenkgabelkopf mit abgedichtetem Rillenkugellager

Radserie 1C

- Polypropylen-Radkörper (RAL 7035) mit thermoplastischer Bandage (TPE, Shore A 87, RAL 7012)
- Fadenschutz (RAL 7035)
- Rillenkugellager
- auch mit anderen Radvarianten lieferbar

Technical description

- fork made of high-strength impact-resistant nylon (RAL 7035)
- swivel fork head with sealed deep groove ball bearing

Wheel series 1C

- polypropylen wheel center (RAL 7035) with thermoplastic tyre (TPE, Shore A 87, RAL 7012)
- thread guard (RAL 7035)
- deep groove ball bearing
- also available with other wheel variants

VIVAX-KSL
VIVAX-KSF
VIVAX-KSD

Lenkrolle / Swivel castor

Lenkrolle mit Totalfeststeller nachlaufend / Swivel castor with total brake mounted behind

Lenkrolle mit Richtungsfeststeller / Swivel castor with directional lock

Michelrollen
Furniture castors

Apparaterollen
Apparatus castors

Medizinisch-Technische Rollen
Medical equipment castors

Transportgeräterollen
Transport appliance castors

Edelstahlrollen
Stainless steel castors

Schwerlastrollen
Heavy duty castors

Bäckerrollen
Bakery castors

Räder
Wheels

Zubehör
Accessories



KSL-31C-L10	75	30	109	41,5	10	70	
KSL-41C-L10	100	32	135	43	10	80	
KSL-51C-L10	125	32	161	46	10	100	
KSL-31C-L12	75	30	109	41,5	12	70	
KSL-41C-L12	100	32	135	43	12	80	
KSL-51C-L12	125	32	161	46	12	100	
KSF-31C-L10	75	30	109	41,5	10	70	
KSF-41C-L10	100	32	135	43	10	80	
KSF-51C-L10	125	32	161	46	10	100	
KSF-31C-L12	75	30	109	41,5	12	70	
KSF-41C-L12	100	32	135	43	12	80	
KSF-51C-L12	125	32	161	46	12	100	
KSD-31C-L10	75	30	109	41,5	10	70	
KSD-41C-L10	100	32	135	43	10	80	
KSD-51C-L10	125	32	161	46	10	100	
KSD-31C-L12	75	30	109	41,5	12	70	
KSD-41C-L12	100	32	135	43	12	80	
KSD-51C-L12	125	32	161	46	12	100	

Technische Beschreibung

- Gabel aus hochfestem schlagzähem Nylon (RAL 7035)
- Lenkgabelkopf mit abgedichtetem Rillenkugellager

Radserie 1C

- Polypropylen-Radkörper (RAL 7035) mit thermoplastischer Bandage (TPE, Shore A 87, RAL 7012)
- Fadenschutz (RAL 7035)
- Rillenkugellager
- auch mit anderen Radvarianten lieferbar

Technical description

- fork made of high-strength impact-resistant nylon (RAL 7035)
- swivel fork head with sealed deep groove ball bearing

Wheel series 1C

- polypropylen wheel center (RAL 7035) with thermoplastic tyre (TPE, Shore A 87, RAL 7012)
- thread guard (RAL 7035)
- deep groove ball bearing
- also available with other wheel variants

VIVAX 2

VIVAX-KSL2 Lenkrolle / Swivel castor

VIVAX-KSF2 Lenkrolle mit Totalfeststeller nachlaufend / Swivel castor with total brake mounted behind



KSL2-41C-L10	100	32	135	46	10	100	
KSL2-51C-L10	125	32	161	46	10	100	
KSL2-41C-L12	100	32	135	46	12	100	
KSL2-51C-L12	125	32	161	46	12	100	
KSF2-41C-L10	100	32	135	46	10	100	
KSF2-51C-L10	125	32	161	46	10	100	
KSF2-41C-L12	100	32	135	46	12	100	
KSF2-51C-L12	125	32	161	46	12	100	

Technische Beschreibung

- Gabel aus hochfestem schlagzähem Nylon (RAL 7035)
- Lenkgabelkopf mit abgedichtetem Rillenkugellager

Radserie 1C

- Polypropylen-Radkörper (RAL 7035) mit thermoplastischer Bandage (TPE, Shore A 87, RAL 7012)
- Fadenschutz (RAL 7035)
- Rillenkugellager
- auch mit anderen Radvarianten lieferbar

Technical description

- fork made of high-strength impact-resistant nylon (RAL 7035)
- swivel fork head with sealed deep groove ball bearing

Wheel series 1C

- polypropylen wheel center (RAL 7035) with thermoplastic tyre (TPE, Shore A 87, RAL 7012)
- thread guard (RAL 7035)
- deep groove ball bearing
- also available with other wheel variants

VIVAX 2
VIVAX-KSL2
VIVAX-KSF2

Lenkrolle / Swivel castor

Lenkrolle mit Totalfeststeller nachlaufend / Swivel castor with total brake mounted behind

Möbelrollen
Furniture castors

Apparaterollen
Apparatus castors

Medizinisch-Technische Rollen
Medical equipment castors

Transportgeräterollen
Transport appliance castors

Edelstahlrollen
Stainless steel castors

Schwerlastrollen
Heavy duty castors

Bäckerrollen
Bakery castors

Räder
Wheels

Zubehör
Accessories



KSL2-41C-P77	100	32	142,5	46	77x66	8,5	61x51/56x46	100	
KSL2-51C-P77	125	32	168,5	46	77x66	8,5	61x51/56x46	100	
KSL2-41C-P95	100	32	142,5	46	95x70	8,5	75x50/72x52	100	
KSL2-51C-P95	125	32	168,5	46	95x70	8,5	75x50/72x52	100	
KSL2-41C-P100	100	32	142,5	46	100x80	9	80x60/76x55	100	
KSL2-51C-P100	125	32	168,5	46	100x80	9	80x60/76x55	100	
KSF2-41C-P77	100	32	142,5	46	77x66	8,5	61x51/56x46	100	
KSF2-51C-P77	125	32	168,5	46	77x66	8,5	61x51/56x46	100	
KSF2-41C-P95	100	32	142,5	46	95x70	8,5	75x50/72x52	100	
KSF2-51C-P95	125	32	168,5	46	95x70	8,5	75x50/72x52	100	
KSF2-41C-P100	100	32	142,5	46	100x80	9	80x75/60x55	100	
KSF2-51C-P100	125	32	168,5	46	100x80	9	80x75/60x55	100	

Technische Beschreibung

- Gabel aus hochfestem schlagzähem Nylon (RAL 7035)
- Lenkgabelkopf mit abgedichtetem Rillenkugellager

Radserie 1C

- Polypropylen-Radkörper (RAL 7035) mit thermoplastischer Bandage (TPE, Shore A 87, RAL 7012)
- Fadenschutz (RAL 7035)
- Rillenkugellager
- auch mit anderen Radvarianten lieferbar

Technical description

- fork made of high-strength impact-resistant nylon (RAL 7035)
- swivel fork head with sealed deep groove ball bearing

Wheel series 1C

- polypropylen wheel center (RAL 7035) with thermoplastic tyre (TPE, Shore A 87, RAL 7012)
- thread guard (RAL 7035)
- deep groove ball bearing
- also available with other wheel variants

TANGO
TANGO

Lenkrolle / Swivel castor

Lenkrolle mit Totalfeststeller nachlaufend / Swivel castor with total brake mounted behind



301719	75	32	110	10	73	70	
301727	100	32	141	10	95	100	
301637	125	32	161	10	110	100	



301731	75	32	110	10	94	70	
301739	100	32	141	10	95	100	
301639	125	32	161	10	110	100	

Technische Beschreibung

- Kunststoffrolle TANGO
- Abgedichtetes Präzisionskugellager im Gabelkopf
- Wartungsfreie Konstruktion
- Auch mit 12 mm Rückenloch erhältlich
- Auf Anfrage auch mit anderen Radvarianten lieferbar

Radserie Tango S-PTE/K 80

- Bandage aus thermoplastischem Gummi (Shore A 80)
- Polypropylen-Radkörper
- Integrierter Kunststoff-Fadenschutz
- Kugellager

Technical description

- TANGO plastic castor
- sealed precision ball bearings in swivel section
- maintenance-free construction
- Fittings: 10 and 12 mm bolt hole, threaded stem and plate
- on request also available with another wheel variants

Wheel series Tango S-PTE/K 80

- thermoplastic rubber tyre (Shore A 80)
- polypropylene wheel body
- integrated plastic thread guards
- ball bearing

TANGO

TANGO

Lenkrolle / Swivel castor

Lenkrolle mit Totalfeststeller nachlaufend / Swivel castor with total brake mounted behind

Möbelrollen
Furniture castors

Apparaterollen
Apparatus castors

Medizinisch-Technische Rollen
Medical equipment castors

Transportgeräterollen
Transport appliance castors

Edelstahlrollen
Stainless steel castors

Schwerlastrollen
Heavy duty castors

Bäckerrollen
Bakery castors

Räder
Wheels

Zubehör
Accessories



304391	75	32	110	10	73	90	
303973	100	32	141	10	95	100	
303977	125	32	161	10	110	100	



304395	75	32	110	10	94	90	
303984	100	32	141	10	95	100	
303988	125	32	161	10	110	100	

Technische Beschreibung

- Kunststoffrolle TANGO
- Abgedichtetes Präzisionskugellager im Gabelkopf
- Wartungsfreie Konstruktion
- Auch mit 12 mm Rückenloch verfügbar
- Auf Anfrage auch mit anderen Radvarianten lieferbar

Radserie Tango S-NP/K

- Bandage aus weichem Polyurethan (Shore A 80) Polyamid-Radkörper
- Integrierter Kunststoff-Fadenschutz
- Kugellager

Technical description

- TANGO plastic castor
- sealed precision ball bearings in swivel section
- maintenance-free construction
- Fittings: 10 and 12 mm bolt hole, threaded stem and plate
- on request also available with another wheel variants

Wheel series Tango S-NP/K

- soft polyurethane tyre (Shore A 80)
- polyamide wheel body
- integrated plastic thread guards
- ball bearing

TANGO
TANGO

Lenkrolle / Swivel castor

Lenkrolle mit Totalfeststeller nachlaufend / Swivel castor with total brake mounted behind



301723	100	32	141	10	95	80		
301668	125	32	161	10	110	100		



301735	100	32	141	10	95	80		
301672	125	32	161	10	110	100		

Technische Beschreibung

- Kunststoffrolle TANGO
- Abgedichtetes Präzisionskugellager im Gabelkopf
- Wartungsfreie Konstruktion
- Auch mit 12 mm Rückenloch verfügbar
- Auf Anfrage auch mit anderen Radvarianten lieferbar

Radserie Tango S-NEK/K

- Bandage aus elastischem Vollgummi (Shore A 60) Polyamid-Radkörper
- Integrierter Kunststoff-Fadenschutz
- Kugellager

Technical description

- TANGO plastic castor
- sealed precision ball bearings in swivel section
- maintenance-free construction
- Fittings: 10 and 12 mm bolt hole, threaded stem and plate
- on request also available with another wheel variants

Wheel series Tango S-NEK/K

- elastic rubber tyre (Shore A 60)
- polyamide wheel body
- integrated plastic thread guards
- ball bearing

TANGO

TANGO

Lenkrolle / Swivel castor

Lenkrolle mit Totalfeststeller nachlaufend / Swivel castor with total brake mounted behind

Michelrollen
Furniture castors

Apparaterollen
Apparatus castors

Medizinisch-Technische Rollen
Medical equipment castors

Transportgeräterollen
Transport appliance castors

Edelstahlrollen
Stainless steel castors

Schwerlastrollen
Heavy duty castors

Bäckerrollen
Bakery castors

Räder
Wheels

Zubehör
Accessories



301743	75	32	110	10x16	73	70	
301751	100	32	141	10x16	95	100	
301649	125	32	161	10x16	110	100	



301755	75	32	110	10x16	94	70	
301763	100	32	141	10x16	95	100	
301651	125	32	161	10x16	110	100	

Technische Beschreibung

- Kunststoffrolle TANGO
- Abgedichtetes Präzisionskugellager im Gabelkopf
- Wartungsfreie Konstruktion
- Auch mit 12 mm Gewindestift erhältlich
- Auf Anfrage auch mit anderen Radvarianten lieferbar

Radserie Tango S-PTE/K 80

- Bandage aus thermoplastischem Gummi (Shore A 80)
- Polypropylen-Radkörper
- Integrierter Kunststoff-Fadenschutz
- Kugellager

Technical description

- TANGO plastic castor
- sealed precision ball bearings in swivel section
- maintenance-free construction
- Fittings: 10 and 12 mm bolt hole, threaded stem and plate
- on request also available with another wheel variants

Wheel series Tango S-PTE/K 80

- thermoplastic rubber tyre (Shore A 80)
- polypropylene wheel body
- integrated plastic thread guards
- ball bearing

TANGO
TANGO

Lenkrolle mit Richtungsfeststeller / Swivel castor with directional lock

Bockrolle / Fixed castor



301767	75	32	110	10x16	94	70	
301775	100	32	141	10x16	95	100	
301707	125	32	161	10x16	110	100	



301033	100	32	141	10x16	100	
301037	125	32	161	10x16	100	

Technische Beschreibung

- Kunststoffrolle TANGO
- Abgedichtetes Präzisionskugellager im Gabelkopf
- Wartungsfreie Konstruktion
- Auch mit 12 mm Gewindestift erhältlich
- Auf Anfrage auch mit anderen Radvarianten lieferbar

Radserie Tango S-PTE/K 80

- Bandage aus thermoplastischem Gummi (Shore A 80)
- Polypropylen-Radkörper
- Integrierter Kunststoff-Fadenschutz
- Kugellager

Technical description

- TANGO plastic castor
- sealed precision ball bearings in swivel section
- maintenance-free construction
- Fittings: 10 and 12 mm bolt hole, threaded stem and plate
- on request also available with another wheel variants

Wheel series Tango S-PTE/K 80

- thermoplastic rubber tyre (Shore A 80)
- polypropylene wheel body
- integrated plastic thread guards
- ball bearing

TANGO
TANGO

Lenkrolle mit Richtungsfeststeller / Swivel castor with directional lock
Bockrolle / Fixed castor



304407	75	32	110	10x16	94	90	
304024	100	32	141	10x16	95	80	
304028	125	32	161	10x16	110	100	



304049	100	32	141	10x16	80	
304051	125	32	161	10x16	100	

Technische Beschreibung

- Kunststoffrolle TANGO
- Abgedichtetes Präzisionskugellager im Gabelkopf
- Wartungsfreie Konstruktion
- Auch mit 12 mm Gewindestift erhältlich
- Auf Anfrage auch mit anderen Radvarianten lieferbar

Radserie Tango S-NP/K

- Bandage aus weichem Polyurethan (Shore A 80)
- Polyamid-Radkörper
- Integrierter Kunststoff-Fadenschutz
- Kugellager

Technical description

- TANGO plastic castor
- sealed precision ball bearings in swivel section
- maintenance-free construction
- Fittings: 10 and 12 mm bolt hole, threaded stem and plate
- on request also available with another wheel variants

Wheel series Tango S-NP/K

- soft polyurethane tyre (Shore A 80)
- polyamide wheel wheel body
- integrated plastic thread guards
- ball bearing

TANGO

TANGO

Lenkrolle / Swivel castor

Lenkrolle mit Totalfeststeller nachlaufend / Swivel castor with total brake mounted behind

Michelrollen
Furniture castors

Apparaterollen
Apparatus castors

Medizinisch-Technische Rollen
Medical equipment castors

Transportgeräterollen
Transport appliance castors

Edelstahlrollen
Stainless steel castors

Schwerlastrollen
Heavy duty castors

Bäckerrollen
Bakery castors

Räder
Wheels

Zubehör
Accessories



301747	100	32	141	10x16	10	95	80	
301676	100	32	141	10x16		95	80	



301759	100	32	141	10x16	10	95	80	
301680	100	32	141	10x16		95	80	

Technische Beschreibung

- Kunststoffrolle TANGO
- Abgedichtetes Präzisionskugellager im Gabelkopf
- Wartungsfreie Konstruktion
- Auch mit 12 mm Gewindestift erhältlich
- Auf Anfrage auch mit anderen Radvarianten lieferbar

Radserie Tango S-NEK/K

- Bandage aus elastischem Vollgummi (Shore A 60)
- Polyamid-Radkörper
- Integrierter Kunststoff-Fadenschutz
- Kugellager

Technical description

- TANGO plastic castor
- sealed precision ball bearings in swivel section
- maintenance-free construction
- Fittings: 10 and 12 mm bolt hole, threaded stem and plate
- on request also available with another wheel variants

Wheel series Tango S-NEK/K

- elastic rubber tyre (Shore A 60)
- polyamide wheel body
- integrated plastic thread guards
- ball bearing

TANGO
TANGO

Lenkrolle mit Richtungsfeststeller / Swivel castor with directional lock
Bockrolle / Fixed castor



301771	100	32	141	10x16	10	95	80	
301703	100	32	141	10x16		95	80	



301035	100	32	141	10x16	80		
301039	100	32	141	10x16	80		

Technische Beschreibung

- Kunststoffrolle TANGO
- Abgedichtetes Präzisionskugellager im Gabelkopf
- Wartungsfreie Konstruktion
- Auch mit 12 mm Gewindestift erhältlich
- Auf Anfrage auch mit anderen Radvarianten lieferbar

Radserie Tango S-NEK/K

- Bandage aus elastischem Vollgummi (Shore A 60)
- Polyamid-Radkörper
- Integrierter Kunststoff-Fadenschutz
- Kugellager

Technical description

- TANGO plastic castor
- sealed precision ball bearings in swivel section
- maintenance-free construction
- Fittings: 10 and 12 mm bolt hole, threaded stem and plate
- on request also available with another wheel variants

Wheel series Tango S-NEK/K

- elastic rubber tyre (Shore A 60)
- polyamide wheel body
- integrated plastic thread guards
- ball bearing

TANGO
TANGO
TANGO

Lenkrolle / Swivel castor

Lenkrolle mit Totalfeststeller nachlaufend / Swivel castor with total brake mounted behind

Bockrolle / Fixed castor

Möbelrollen
Furniture castors

Apparaterollen
Apparatus castors

Medizinisch-Technische Rollen
Medical equipment castors

Transportgeräterollen
Transport appliance castors

Edelstahlrollen
Stainless steel castors

Schwerlastrollen
Heavy duty castors

Bäckerrollen
Bakery castors

Räder
Wheels

Zubehör
Accessories



301779	75	32	117	77x67	8	61/51x50/42		73	70
301787	100	32	148	77x67	8	61/51x50/42		95	100
301688	125	32	168	77x67	8	61/51x50/42		110	100



301791	75	32	117	77x67	8	61/51x50/42		94	70
301799	100	32	148	77x67	8	61/51x50/42		95	100
301697	125	32	168	77x67	8	61/51x50/42		110	100



301041	100	32	148	77x67	8	61/51x50/42	100	
301045	125	32	168	77x67	8	61/51x50/42	100	

Technische Beschreibung

- Kunststoffrolle TANGO
- Abgedichtetes Präzisionskugellager im Gabelkopf
- Wartungsfreie Konstruktion
- Auf Anfrage auch mit anderen Radvarianten lieferbar

Radserie Tango S-PTE/K 80

- Bandage aus thermoplastischem Gummi (Shore A 80)
- Polypropylen-Radkörper
- Integrierter Kunststoff-Fadenschutz
- Kugellager

Technical description

- TANGO plastic castor
- sealed precision ball bearings in swivel section
- maintenance-free construction
- Fittings: 10 and 12 mm bolt hole, threaded stem and plate
- on request also available with another wheel variants

Wheel series Tango S-PTE/K 80

- thermoplastic rubber tyre (Shore A 80)
- polypropylene wheel body
- integrated plastic thread guards
- ball bearing

TANGO
TANGO
TANGO

Lenkrolle / Swivel castor

Lenkrolle mit Totalfeststeller nachlaufend / Swivel castor with total brake mounted behind

Bockrolle / Fixed castor



304410	75	32	117	77x67	8	61/51x50/42	73	90		
304033	100	32	148	77x67	8	61/51x50/42	95	100		
304035	125	32	168	77x67	8	61/51x50/42	110	100		



304412	75	32	117	77x67	8	61/51x50/42	94	90		
304039	100	32	148	77x67	8	61/51x50/42	95	100		
304041	125	32	168	77x67	8	61/51x50/42	110	100		



304053	100	32	148	77x67	8	61/51x50/42	100			
304055	125	32	168	77x67	8	61/51x50/42	100			

Technische Beschreibung

- Kunststoffrolle TANGO
- Abgedichtetes Präzisionskugellager im Gabelkopf
- Wartungsfreie Konstruktion
- Auf Anfrage auch mit anderen Radvarianten lieferbar

Radserie Tango S-NP/K

- Bandage aus weichem Polyurethan (Shore A 80)
- Polyamid-Radkörper
- Integrierter Kunststoff-Fadenschutz
- Kugellager

Technical description

- TANGO plastic castor
- sealed precision ball bearings in swivel section
- maintenance-free construction
- Fittings: 10 and 12 mm bolt hole, threaded stem and plate
- on request also available with another wheel variants

Wheel series Tango S-NP/K

- soft polyurethane tyre (Shore A 80)
- polyamide wheel wheel body
- integrated plastic thread guards
- ball bearing

TANGO
TANGO
TANGO

Lenkrolle / Swivel castor

Lenkrolle mit Totalfeststeller nachlaufend / Swivel castor with total brake mounted behind

Bockrolle / Fixed castor

Michelrollen
Furniture castors

Apparaterollen
Apparatus castors

Medizinisch-Technische Rollen
Medical equipment castors

Transportgeräterollen
Transport appliance castors

Edelstahlrollen
Stainless steel castors

Schwerlastrollen
Heavy duty castors

Bäckerrollen
Bakery castors

Räder
Wheels

Zubehör
Accessories



301783	100	32	148	77x67	8	61/51x50/42	95	80		
301684	100	32	168	77x67	8	61/51x50/42	110	100		



301795	100	32	148	77x67	8	61/51x50/42	95	80		
301693	100	32	168	77x67	8	61/51x50/42	110	100		



301043	100	32	148	77x67	8	61/51x50/42	80			
301047	100	32	168	77x67	8	61/51x50/42	100			

Technische Beschreibung

- Kunststoffrolle TANGO
- Abgedichtetes Präzisionskugellager im Gabelkopf
- Wartungsfreie Konstruktion
- Auf Anfrage auch mit anderen Radvarianten lieferbar

Radserie Tango S-NEK/K

- Bandage aus elastischem Vollgummi (Shore A 60)
- Polyamid-Radkörper
- Integrierter Kunststoff-Fadenschutz
- Kugellager

Technical description

- TANGO plastic castor
- sealed precision ball bearings in swivel section
- maintenance-free construction
- Fittings: 10 and 12 mm bolt hole, threaded stem and plate
- on request also available with another wheel variants

Wheel series Tango S-NEK/K

- elastic rubber tyre (Shore A 60)
- polyamide wheel body
- integrated plastic thread guards
- ball bearing

TWIST
TWIST
TWIST

Lenkrolle / Swivel castor

Lenkrolle mit Totalfeststeller nachlaufend / Swivel castor with total brake mounted behind

Lenkrolle mit Richtungsfeststeller / Swivel castor with directional lock



305294	75	2x15 (71)	80	10	61	95		
305130	100	2x20 (81)	118	10	89	125		
305010	125	2x20 (81)	143	10	102	125		



305295	75	2x15 (71)	80	10	85	95		
305131	100	2x20 (81)	118	10	113	125		
305011	125	2x20 (81)	143	10	133	125		



305378	125	2x20 (81)	143	10	133	125		

Technische Beschreibung

- Kunststoffdoppelrolle TWIST
- Gabel und Radkörper aus glasfaserverstärktem Polyamid Wartungsfreie Konstruktion
- Befestigungen: 10 und 12 mm Rückenloch sowie Platte
- Auf Anfrage auch mit anderen Radvarianten lieferbar

Radserie TWIST-S-GP/K

- Bandage aus Polyurethan (Shore A 95)
- Glasfaserverstärkter Polyamid-Radkörper
- Kugellager

Technical description

- TWIST plastic twin wheel castor
- fork is made of glass fiber-reinforced polyamide
- maintenance-free construction
- Fittings: 10 und 12 mm bolt hole and top plate
- on request also available with other wheel variants and lower overall height

Wheel series TWIST-S-GP/K

- polyurethane tyre (Shore A 95)
- glass fiber-reinforced polyamide wheel centre
- ball bearing

TWIST TWIST

Lenkrolle / Swivel castor

Lenkrolle mit Totalfeststeller nachlaufend / Swivel castor with total brake mounted behind



305301	75	2x15 (71)	89	77x67	8	61/51x50/42	61	80		
305271	100	2x20 (81)	127	77x67	8	61/51x50/42	89	100		
305281	125	2x20 (81)	152	77x67	8	61/51x50/42	102	100		



305302	75	2x15 (71)	89	77x67	8	61/51x50/42	85	80		
305272	100	2x20 (81)	127	77x67	8	61/51x50/42	113	100		
305282	125	2x20 (81)	152	77x67	8	61/51x50/42	133	100		

Michelrollen
Furniture castors

Apparaterollen
Apparatus castors

Medizinisch-Technische Rollen
Medical equipment castors

Transportgeräterollen
Transport appliance castors

Edelstahlrollen
Stainless steel castors

Schwerlastrollen
Heavy duty castors

Bäckerrollen
Bakery castors

Räder
Wheels

Zubehör
Accessories

Technische Beschreibung

- Kunststoffdoppelrolle TWIST
- Gabel und Radkörper aus glasfaserverstärktem Polyamid Wartungsfreie Konstruktion
- Befestigungen: 10 und 12 mm Rückenloch sowie Platte
- Auf Anfrage auch mit anderen Radvarianten lieferbar

Radserie TWIST-S-GP/K

- Bandage aus Polyurethan (Shore A 95)
- Glasfaserverstärkter Polyamid-Radkörper
- Kugellager

Technical description

- TWIST plastic twin wheel castor
- fork is made of glass fiber-reinforced polyamide
- maintenance-free construction
- Fittings: 10 und 12 mm bolt hole and top plate
- on request also available with other wheel variants and lower overall height

Wheel series TWIST-S-GP/K

- polyurethane tyre (Shore A 95)
- glass fiber-reinforced polyamide wheel centre
- ball bearing

381a Lenkrolle / Swivel castor

381h Lenkrolle mit Totalfeststeller nachlaufend / Swivel castor with total brake mounted behind



381a 40K075v KGD	75	59/2x10	95		M12x25		•
381a 40K100v KGD	100	66/2x12	125		M12x25		•
381a 40K125v KGD	125	76/2x12	146		M12x25		•



381h 40K075v KGD	75	59/2x10	95		M12x25		•
381h 40K100v KGD	100	66/2x12	125		M12x25		•
381h 40K125v KGD	125	76/2x12	146		M12x25		•



381a 40K075v KPS	75	59/2x10	105	94X64	8,5	78/72X45		•
381a 40K100v KPS	100	66/2x12	135	94X64	8,5	78/72X45		•
381a 40K125v KPS	125	76/2x12	158	94X64	8,5	78/72X45		•



381h 40K075v KPS	75	59/2x10	105	94X64	8,5	78/72X45		•
381h 40K100v KPS	100	66/2x12	135	94X64	8,5	78/72X45		•
381h 40K125v KPS	125	76/2x12	158	94X64	8,5	78/72X45		•

• Artikel auf Anfrage / product on request

Technische Beschreibung

- Kunststoffrolle
- Schwenklager mit zweireihigem Kugellauf
- Räder mit geringem Rollwiderstand
- durch das besondere Design der Rolle werden die Achse und das Lager vor Schmutz und Wasser geschützt
- Rolle mit Raddurchmesser 125 mm auch verfügbar mit Zapfen K622 (28x45 mm)

Radserie 40Kv

- thermoplastische Polyurethan-Bandage (TPU, Shore A 95)
- Präzisionskugellager
- kontaktverfärbungsfrei

Technical description

- plastic castor
- wheels have easy rollability
- the design protects axle / bearing areas from hair / water
- total lock models lock both the wheel and swivel
- also available wheel diameter 125 mm with fixing stem K622 (28x45 mm)

Wheel series 40Kv

- thermoplastic polyurethane tyre (TPU, Shore A 95)
- precision ball bearing
- free of contact discoloration

AVANT Lenkrolle / Swivel castor

AVANT-TL Lenkrolle mit Totalfeststeller nachlaufend / Swivel castor with total brake mounted behind

AVANT-DL Lenkrolle mit Richtungsfeststeller / Swivel castor with directional lock

Michelrollen
Furniture castors



Apparaterollen
Apparatus castors

Medizinisch-Technische Rollen
Medical equipment castors



Transportgeräterollen
Transport appliance castors



Edelstahlrollen
Stainless steel castors

Schwerlastrollen
Heavy duty castors

Bäckerrollen
Bakery castors

Räder
Wheels

Zubehör
Accessories

	AV04QRP125SWTP11	100	32	146	36	77x67	8	61x51/56x46	100	•
	AV05QRP125SWTP11	125	32	170	40	77x67	8	61x51/56x46	100	•
	AV06QRP125SWTP11	150	32	195	45	77x67	8	61x51/56x46	100	•
	AV03QRP100SWTP13	75	25	110	27	95x70	8	75x45/72x52	80	•
	AV04QRP125SWTP13	100	32	146	36	95x70	8	75x45/72x52	100	•
	AV05QRP125SWTP13	125	32	170	40	95x70	8	75x45/72x52	100	•
	AV06QRP125SWTP13	150	32	195	45	95x70	8	75x45/72x52	100	•
	AV04QRP125TLTP11	100	32	146	36	77x67	8	61x51/56x46	100	•
	AV05QRP125TLTP11	125	32	170	40	77x67	8	61x51/56x46	100	•
	AV06QRP125TLTP11	150	32	195	45	77x67	8	61x51/56x46	100	•
	AV03QRP100TBTP13	75	25	110	27	95x70	8	75x45/72x52	80	•
	AV04QRP125TLTP13	100	32	146	36	95x70	8	75x45/72x52	100	•
	AV05QRP125TLTP13	125	32	170	40	95x70	8	75x45/72x52	100	•
	AV06QRP125TLTP13	150	32	195	45	95x70	8	75x45/72x52	100	•
	AV04QRP125DLTP11	100	32	146	36	77x67	8	61x51/56x46	100	•
	AV05QRP125DLTP11	125	32	170	40	77x67	8	61x51/56x46	100	•
	AV06QRP125DLTP11	150	32	195	45	77x67	8	61x51/56x46	100	•
	AV04QRP125DLTP13	100	32	146	36	95x70	8	75x45/72x52	100	•
	AV05QRP125DLTP13	125	32	170	40	95x70	8	75x45/72x52	100	•
	AV06QRP125DLTP13	150	32	195	45	95x70	8	75x45/72x52	100	•

• Artikel auf Anfrage / product on request

Technische Beschreibung

- Kunststoffrolle
- Abgedichtetes Präzisionskugellager im Gabelkopf
- Wartungsfreie Konstruktion
- auch mit grauem Totalfeststeller lieferbar

Radserie

- Geräuscharmes und kontaktverfärbungsfreies QuikStart-Rad
- TPE-Bandage RAL 7011 (Shore A 70)
- Kunststoff-Radkörper RAL 7001
- Integrierter Kunststoff-Fadenschutz für Langlebigkeit des Rades, RAL 7011
- Präzisionskugellager

Technical description

- plastic castor with sealed precision ball bearings in swivel section
- maintenance-free construction
- also available with grey total brake pedal

Wheel series

- non-marking QuikStart wheel
- TPE tyre RAL 7011 (Shore A 70)
- plastic wheel body RAL 7001
- integrated plastic thread guards for wheel protection and long life, RAL 7011
- precision ball bearing

AVANT Lenkrolle / Swivel castor

AVANT-TL Lenkrolle mit Totalfeststeller nachlaufend / Swivel castor with total brake mounted behind

AVANT-DL Lenkrolle mit Richtungsfeststeller / Swivel castor with directional lock



AV04QRP125SWHK01	100	32	139	36	13	100	•
AV05QRP125SWHK01	125	32	162	40	13	100	•
AV06QRP125SWHK01	150	32	188	45	13	100	•
AV04QRP125SWHK04	100	32	139	36	11	100	•
AV05QRP125SWHK04	125	32	162	40	11	100	•
AV06QRP125SWHK04	150	32	188	45	11	100	•



AV04QRP125TLHK01	100	32	139	36	13	100	•
AV05QRP125TLHK01	125	32	162	40	13	100	•
AV06QRP125TLHK01	150	32	188	45	13	100	•
AV04QRP125TLHK04	100	32	139	36	11	100	•
AV05QRP125TLHK04	125	32	162	40	11	100	•
AV06QRP125TLHK04	150	32	188	45	11	100	•



AV04QRP125DLHK01	100	32	139	36	13	100	•
AV05QRP125DLHK01	125	32	162	40	13	100	•
AV06QRP125DLHK01	150	32	188	45	13	100	•
AV04QRP125DLHK04	100	32	139	36	11	100	•
AV05QRP125DLHK04	125	32	162	40	11	100	•
AV06QRP125DLHK04	150	32	188	45	11	100	•

• Artikel auf Anfrage / product on request

Technische Beschreibung

- Kunststoffrolle
- Abgedichtetes Präzisionskugellager im Gabelkopf
- Wartungsfreie Konstruktion
- auch mit grauem Totalfeststeller lieferbar

Radserie

- Geräuscharm und kontaktverfärbungsfreies QuikStart-Rad
- TPE-Bandage RAL 7011 (Shore A 70)
- Kunststoff-Radkörper RAL 7001
- Integrierter Kunststoff-Fadenschutz für Langlebigkeit des Rades, RAL 7011
- Präzisionskugellager

Technical description

- plastic castor with sealed precision ball bearings in swivel section
- maintenance-free construction
- also available with grey total brake pedal

Wheel series

- non-marking QuikStart wheel
- TPE tyre RAL 7011 (Shore A 70)
- plastic wheel body RAL 7001
- integrated plastic thread guards for wheel protection and long life, RAL 7011
- precision ball bearing

AVANT Lenkrolle / Swivel castor

AVANT-TL Lenkrolle mit Totalfeststeller nachlaufend / Swivel castor with total brake mounted behind

Möbelrollen / Furniture castors
 Apparaterollen / Apparatus castors
Medizinisch-Technische Rollen / Medical equipment castors
 Transportgeräterollen / Transport appliance castors
 Edelstahlrollen / Stainless steel castors
 Schwerlastrollen / Heavy duty castors
 Backerrollen / Bakery castors
 Räder / Wheels
 Zubehör / Accessories



AV05QRP125SWTS07	125	32	162	40	M 12x21,5	100	•



AV05QRP125TLTS07	125	32	162	40	M 12x21,5	100	•

• Artikel auf Anfrage / product on request

Technische Beschreibung

- Kunststoffrolle
- Abgedichtetes Präzisionskugellager im Gabelkopf
- Wartungsfreie Konstruktion
- auch mit grauem Totalfeststeller lieferbar

Radserie

- Geräuscharmes und kontaktverfärbungsfreies QuikStart-Rad
- TPE-Bandage RAL 7011 (Shore A 70)
- Kunststoff-Radkörper RAL 7001
- Integrierter Kunststoff-Fadenschutz für Langlebigkeit des Rades, RAL 7011
- Präzisionskugellager

Technical description

- plastic castor with sealed precision ball bearings in swivel section
- maintenance-free construction
- also available with grey total brake pedal

Wheel series

- non-marking QuikStart wheel
- TPE tyre RAL 7011 (Shore A 70)
- plastic wheel body RAL 7001
- integrated plastic thread guards for wheel protection and long life, RAL 7011
- precision ball bearing

GENESIS

PGE ... Lenkrolle / Swivel castor

PGE .../B Lenkrolle mit Totalfeststeller nachlaufend / Swivel castor with total brake mounted behind



PGE30403WH-MNT33(GG)	75	25	100	37	10	50	•
PGE40400WH-MNT63(GG)	100	32	136,5	45	10	100	•



PGE30403WH-MNT33(GG)B	75	25	100	37	10	50	•
PGE40400WH-MNT63(GG)B	100	32	136,5	45	10	100	•

• Artikel auf Anfrage / product on request

Technische Beschreibung

- Kunststoffrolle aus Polyamid
- Abgedichtetes Präzisionskugellager im Gabelkopf
- Robustes Gehäuse schützt die Komponenten und ermöglicht eine leichte Reinigung
- Auf Anfrage auch mit anderen Befestigungen (Platte, Gewindestift, etc.) und mit anderen Farben (grau & schwarz) verfügbar

Radserie WH

- MonoTech-Rad mit kontaktverfärbungsfreier weicher Bandage (Shore A 65)
- Präzisionskugellager
- Integrierter Fadenschutz schützt die Räder vor eindringendem Schmutz
- Perfekte Einsatzmöglichkeiten auf jeglichen Böden

Technical description

- Plastic castor (polyamide)
- Sealed precision bearing in swivel head provide quiet, effortless mobility
- Strong protective body conceals components for easy cleaning
- On request available with further fittings (plate, threaded stem, etc.) and in different colours (grey & black)

Wheel series WH

- MonoTech wheel with non-marking soft tyre (Shore A 65)
- Precision ball bearing
- Integrated thread guards protect wheels from entangling debris
- Excellent application options on any floor type

Hilfestellung Guideline

A. Feststelltypen zu den Bestellangaben für zentralfeststellbare Rollen Locking brakes for ordering designations for hospital bed castors

Möbelrollen
Furniture castors
Apparaterollen
Apparatus castors
Medizinisch-Technische Rollen
Medical equipment castors
Transportgeräterollen
Transport appliance castors
Edelstahlrollen
Stainless steel castors
Schwerlastrollen
Heavy duty castors
Bäckereierollen
Bakery castors
Räder
Wheels
Zubehör
Accessories

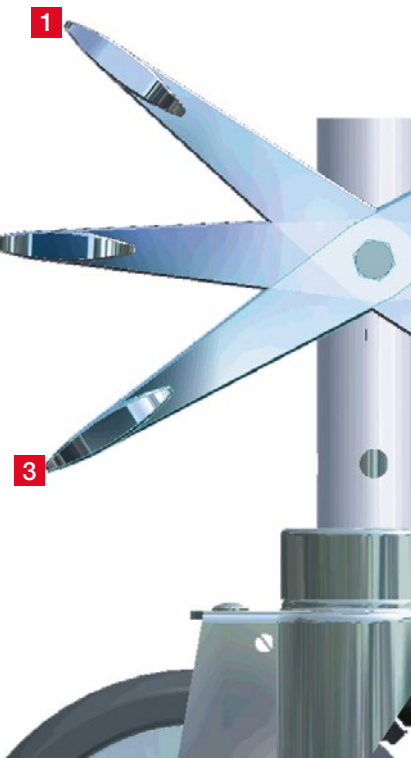

Zentralfeststeller

Krankbetten müssen leicht und zuverlässig manövrierbar sein. Moderne Krankbetten sind daher mit Zentralfeststell-Mechanismen ausgerüstet, die eine Zeit und Kräfte sparende Bedienung ermöglichen.

Central locking brakes

Hospital beds must be reliable and easy to manoeuvre. Modern hospital beds are therefore equipped with central locking brake mechanisms, which enable time and energy-saving operation.

Richtungsfeststeller

Zur Fixierung des Geradeauslaufs wird der Einsatz eines im Schaltsystem integrierten Richtungsfeststellers empfohlen.

Directional locking brake

For setting of straight ahead motion, the use of a directional locking brake integrated in the fixing stem is recommended.

Der Mechanismus erlaubt eine zentrale Schaltung bzw. Auslösung von:

The mechanism allows a central pedal to select the following modes of operation:

- 1** Geradeauslauf (nur bei Ausrüstung mit Richtungsfeststeller)
- 2** freie Beweglichkeit aller Rollen
- 3** Totalblockierung aller vier Rollen

- 1** Motion straight ahead (only when equipped with directional locking brake mode)
- 2** Changes of direction: free mobility of all castors
- 3** Full locking of all four castors

Weitere Informationen unter www.colson-rollen.com
Further information: www.colson-castors.de

B. Zapfenbefestigung

Fixing stems

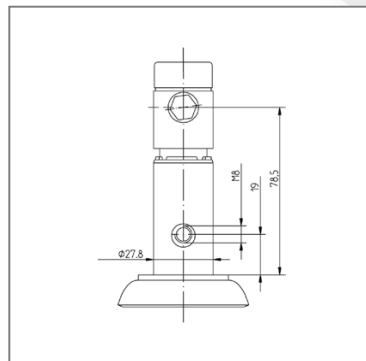
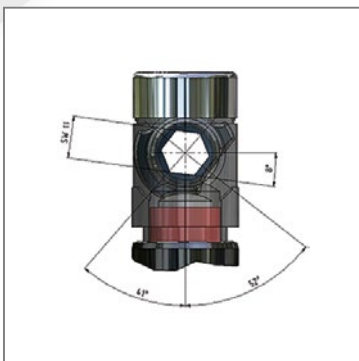

Standardexzenter Standard-cam

(41° und 52°)

Befestigung Zapfen 78,5 mm

- für Standardrohrmaß Ø 28
- Schaltwellenvarianten A/B
- Schaltwelle wahlweise quer oder in Fahrtrichtung
- Gewindebohrung 4-fach
- Ausgleichshülsen für weitere Rohrabmessungen möglich! (siehe Seite 101, 4. Ziffer)

Fixing stem 78,5 mm

- For standard insertion measurement Ø 28
- Switching shaft variants A/B
- Switching shaft in line or across direction of travel
- Four tapped fixing holes
- Snap-on adapter sleeves for different tube measurements available! (see on page 101, 4. digit)

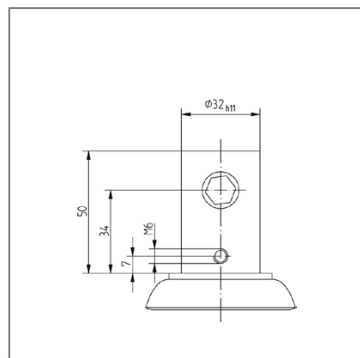
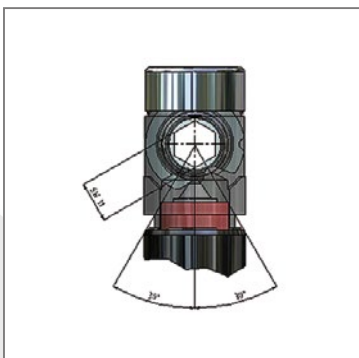

Sonderexzenter Special-cam

(30°)

Befestigung Zapfen 34 mm

- für Standardrohrmaß Ø 32
- Schaltwellenvarianten A/B
- Schaltwelle wahlweise quer oder in Fahrtrichtung
- Gewindebohrung 4-fach

Fixing stem 34 mm

- For standard insertion measurement Ø 32
- Switching shaft variants A/B
- Switching shaft in line or across direction of travel
- Four tapped fixing holes

Der vierstellige Bestellcode

The 4-digit order number

Die vierstellige Bestell-Kennzahl,
z. B. **390q** | **29K** | **150v** | **Z2351**

How to use the 4-digit order number,
e.g. **390q** | **29K** | **150v** | **Z2351**

Für die Bestellung zentralfeststellbarer Rollen sind folgende Angaben zu machen, die an unsere Artikelnummer angefügt werden müssen:

For ordering central locking castors further information need to be added to our reference number:

1. Ziffer 1. Digit	Abstand Schaltwelle zur Bettenrohrauflage* Distance from the tube seat to middle of the switching bar*	Exzenterart Kind of cam	Schaltwelle Switching shaft	A A	B B
2	x = 78,5 mm	Standard-Exzenter Standard-cam	A		
4	x = 78,5 mm	30°-Exzenter 30°-cam	A		
6	x = 78,5 mm	14-12-Exzenter 14-12-cam	B		
8	x = 34,0 mm	Standard-Exzenter Standard-cam	A		
9	x = 34,0 mm	30°-Exzenter 30°-cam	A		

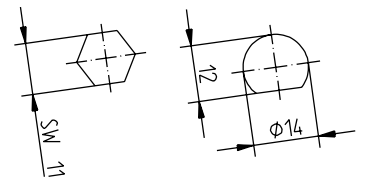

* auf Anfrage: 71 mm möglich
* on request: 71 mm possible

2. Ziffer 2. Digit	Gewindebohrungsmaß* Size of the threaded hole*	Abstand zur Bettenrohrauflage Distance from the tube seat to the middle of the threaded hole
3	M8	y = 19 mm
8	M6	y = 7 mm

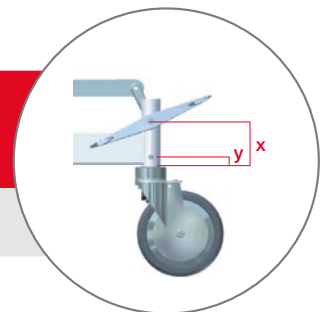

* auf Anfrage: M6/18 mm und M8/18 mm möglich
* on request: M6/18 mm and M8/18 mm possible

Möbelrollen Furniture castors
 Apparaterollen Apparatus castors
Medizinisch-Technische Rollen Medical equipment castors
 Transporterrollen Transport appliance castors
 Edelstahlrollen Stainless steel castors
 Schwerlastrollen Heavy duty castors
 Backerrollen Bakery castors
 Räder Wheels
 Zubehör Accessories

	Lage Schaltwelle zur Fahrtrichtung Position of the bar to the travel direction	Lage Gewindebohrung zur Fahrtrichtung Position of the threaded hole to the travel direction
3. Ziffer 3. Digit		
5	quer across	4-fach 4-tapped holes
6	in along	4-fach 4-tapped holes



Ausführung I Type I

Schaltwelle quer zur Fahrtrichtung
Foot pedal across direction of travel



Ausführung II Type II

Schaltwelle in Fahrtrichtung
Foot pedal along direction of travel

4. Ziffer 4. Digit	Adaptermaß Adapter measurement	lose Hülse (Art.-Nr.) socket (Art. No.)		Adaptermaß Adapter measurement	lose Hülse (Art.-Nr.) socket (Art. No.)
0	ohne without				
1	Ø 27,8	9 229 111	5	Ø 28,9	9 229 048
2	Ø 28	9 229 050	6	Ø 33,65	9 229 029
3	Ø 28,2	9 229 025	7	Ø 33,65	9 229 023
4	Ø 28,4	9 229 026	8	Ø 36	HB 22 + 9 229 111

nur für Zapfen
71 mm und
78,5 mm
only for stems
71 mm and
78,5 mm

Zubehör Accessories

Für zentralfeststellbare Krankenbettenrollen
For central locking hospital bed castors

Möbelrollen Furniture castors
 Apparaterollen Apparatus castors
Medizinisch-Technische Rollen Medical equipment castors
 Transportgeräterollen Transport appliance castors
 Edelstahlrollen Stainless steel castors
 Schwerlastrollen Heavy duty castors
 Backenrollen Bakery castors
 Räder Wheels
 Zubehör Accessories

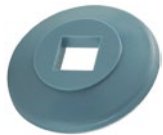

Abwehräder 49G
Wall bumper 49G

Durchmesser 95 mm
Diameter



Genauere Farben und Abmessungen auf Anfrage.
Detailed Color and measurement specifications on request.



Rohausgleichshülsen*
Snap-on adapter sleeves*

rund | round



Rohausgleichshülsen*
Snap-on adapter sleeves*

vierkant | square

* siehe Adaptermaße auf Seite
* see adapter measurements on page



Doppeltritthebel
Foot pedal double

links | left DHL
rechts | right DHR



Doppeltritthebel (Kunststoff)
Foot pedal double (plastic)

links | left KDH-9010/7037-30° o. 45°
rechts | right KDH-9010/7037-30° o. 45°



Einfachtritthebel
Foot pedal single

links | left EHL
rechts | right EHR



Einfachtritthebel (Kunststoff)
Foot pedal single (plastic)

links | left KEHL-9010/7016-30° o. 45°
rechts | right KEHR-9010/7016-30° o. 45°



Mitnehmerhebel
Transmission lever

lang | long MNL



Mitnehmerhebel
Transmission lever

kurz | short MNK

**Sie haben spezielle
Anforderungen?
Sprechen Sie uns an.
Wir entwickeln gemeinsam
mit Ihnen eine Lösung.**
You have special requests?
Contact us.
We develop a solution
together with you.

**Ihr
Lösungs-
Partner**
Your
Solutions-
Partner

Transportgeräterollen

Transport appliance castors

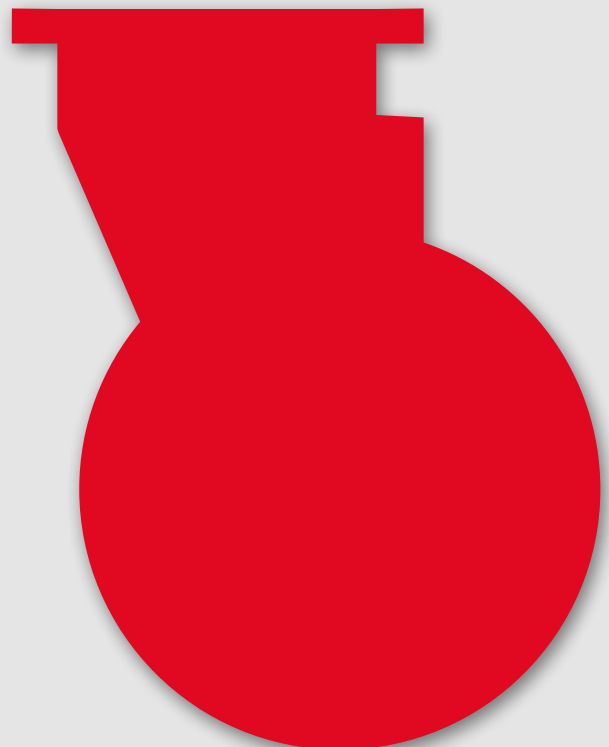

440a Lenkrolle / Swivel castor

438a Bockrolle / Fixed castor



440a 00R058z ZPS		58	29	75	15	79x60	6,5	60x40	80
440a 00R065z ZPS		65	33	88	20	95x70	6,5	75x45	100
440a 00R080z ZPS		80	33	100	20	102x79	8,5	85x60	125
440a 00R100z ZPS		100	40	125	20	133x104	8,5	104x77	200
438a 00R058z ZPS		58	29	75		95x54	6,5	71x24	80
438a 00R065z ZPS		65	33	88		95x54	6,5	71x24	100
438a 00R080z ZPS		80	33	100		128x65	8,5	102x31	125
438a 00R100z ZPS		100	40	125		161x82	8,5	127x43	200

Möbelrollen
Furniture castors

Apparaterollen
Apparatus castors

Medizinisch-Technische Rollen
Medical equipment castors

Transportgeräterollen
Transport appliance castors

Edelstahlrollen
Stainless steel castors

Schwerlastrollen
Heavy duty castors

Bäckerrollen
Bakery castors

Räder
Wheels

Zubehör
Accessories

Technische Beschreibung

- Stahlblechgehäuse
- verzinkt-passiviert
- Schwenklager mit einreihigem Kugellauf
- Radachse verschraubt

Radserie 00Rz

- Polypropylen schwarz
- Rollenlager

Technical description

- sheet steel metal housing
- zinc passivated
- swivel bearing with double ball race
- wheel axis screwed-on

Wheel series 00Rz

- polypropylene black
- roller bearing

441a Lenkrolle / Swivel castor

441h Lenkrolle mit Totalfeststeller nachlaufend / Swivel castor with total brake mounted behind

441i Lenkrolle mit Totalfeststeller vorlaufend / Swivel castor with total brake mounted in front

439a Bockrolle / Fixed castor



441a 08R080c ZPH	80	20	107	34	104x80	9	72x52/80x60	50	
441a 08R100c ZPH	100	22	128	34	104x80	9	72x52/80x60	70	
441a 08R125c ZPH	125	22	152	32	104x80	9	72x52/80x60	100	
441a 08R125c ZPI	125	25	156	37	115x85	9	80x55/60	100	
441a 08R160c ZPK	160	28	197	48	138x109	11	105x75/80	135	
441a 08R200c ZPK	200	31	237	58	138x109	11	105x75/80	205	



441h 08R080c ZPH	80	20	107	34	104x80	9	72x52/80x60	50	
441h 08R100c ZPH	100	22	128	34	104x80	9	72x52/80x60	70	
441h 08R125c ZPH	125	22	152	32	104x80	9	72x52/80x60	100	
441h 08R125c ZPI	125	25	156	37	115x85	9	80x55/60	100	
441h 08R160c ZPK	160	28	197	48	138x109	11	105x75/80	135	
441h 08R200c ZPK	200	31	237	58	138x109	11	105x75/80	205	



441i 08R160c ZPK	160	28	197	48	138x109	11	105x75/80	135	
441i 08R200c ZPK	200	31	237	58	138x109	11	105x75/80	205	



439a 08R080c ZPG	80	20	107		104x84	9	72x52/80x60	50	
439a 08R100c ZPG	100	22	128		104x84	9	72x52/80x60	70	
439a 08R125c ZPG	125	22	152		104x84	9	72x52/80x60	100	
439a 08R125c ZPI	125	25	156		115x85	9	80x55/60	100	
439a 08R160c ZPK	160	28	197		138x109	11	105x75/80	135	
439a 08R200c ZPK	200	31	237		138x109	11	105x75/80	205	

Technische Beschreibung

- stabile Stahlblechkonstruktion und bewährte Technik
- leichtgängiger, zweireihiger Kugelkranz für gute Manövrierbarkeit
- für Serie 441a ab Raddurchmesser 160 mm steht optional eine anschraubbare Lenksperrung »ASLaZ« zur Verfügung (separat bestellbar, siehe Kapitel »Zubehör«)

Radserie 08Rc

- Vollgummireifen schwarz (Shore A 80)
- Stahlblechfelge verzinkt-passiviert
- Rollenlager
- große Rädervielfalt für unterschiedliche Einsatzzwecke, siehe Kapitel »Räder«

Technical description

- stable sheet steel design and proven technology
- easy running double ball bearing for good manoeuvrability
- for series 441a starting from wheel diameter 160 mm a screw-on directional lock »ASLaZ« is available optionally (can be ordered separately, see chapter »Accessories«)

Wheel series 08Rc

- solid rubber tyre black (Shore A 80)
- sheet steel metal rim zinc passivated
- roller bearing
- wide choice of wheels for different areas of application, see chapter »Wheels«

441a Lenkrolle / Swivel castor

441h Lenkrolle mit Totalfeststeller nachlaufend / Swivel castor with total brake mounted behind

439a Bockrolle / Fixed castor



Icon	Wheel Diameter	Stem Diameter	Stem Length	Stem Width	Plate Size	Plate Thickness	Plate Size	Plate Thickness	Weight	Availability
	80	22	112	35	100x80	9	80x60	70	•	
441a 08R080c ZPH-5	80	22	112	35	100x80	9	80x60	70	•	
441a 08R100c ZPH-5	100	22	128	39	100x80	9	80x60	90	•	
441a 08R125c ZPH-5	125	28	152	35	100x80	9	80x60	120	•	
441a 08R160c ZPK-5	160	30	193	57	140x110	11	105x80	200	•	
441a 08R200c ZPK-5	200	30	232	62	140x110	11	105x80	230	•	
	80	22	112	35	100x80	9	80x60	70	•	
441h 08R080c ZPH-5	80	22	112	35	100x80	9	80x60	70	•	
441h 08R100c ZPH-5	100	22	128	39	100x80	9	80x60	90	•	
441h 08R125c ZPH-5	125	28	152	35	100x80	9	80x60	120	•	
441h 08R160c ZPK-5	160	30	193	57	140x110	11	105x80	200	•	
441h 08R200c ZPK-5	200	30	232	62	140x110	11	105x80	230	•	
	80	22	112		100x84	9	80x60	70	•	
439a 08R080c ZPG-5	80	22	112		100x84	9	80x60	70	•	
439a 08R100c ZPG-5	100	22	128		100x84	9	80x60	90	•	
439a 08R125c ZPG-5	125	28	152		100x84	9	80x60	120	•	
439a 08R160c ZPK-5	160	30	193		146x107	11	105x80	200	•	
439a 08R200c ZPK-5	200	30	232		146x107	11	105x80	230	•	

• Artikel auf Anfrage / product on request

Technische Beschreibung

- stabile Stahlblechkonstruktion und bewährte Technik
- leichtgängiger, zweireihiger Kugelkranz für gute Manövrierbarkeit
- Dichtring im Gabelkopf

Radserie 08Rc

- Vollgummireifen schwarz (Shore A 80)
- Stahlblechfelge verzinkt-passiviert
- Rollenlager

Technical description

- Stable sheet steel design and proven technology
- Easy running double ball bearing for good manoeuvrability
- Sealing ring in swivel head







Wheel series 08Rc

- solid rubber tyre black (Shore A 80)
- sheet steel metal rim zinc passivated
- roller bearing







441a Lenkrolle / Swivel castor

441h Lenkrolle mit Totalfeststeller nachlaufend / Swivel castor with total brake mounted behind



							
441a 08R080c ZLD	80	20	105,5	34	12,2	50	
441a 08R100c ZLD	100	22	128	34	12,2	70	
441a 08R125c ZLD	125	22	151	32	12,2	100	



							
441h 08R080c ZLD	80	20	105,5	34	12,2	50	
441h 08R100c ZLD	100	22	128	34	12,2	70	
441h 08R125c ZLD	125	22	151	32	12,2	100	

Technische Beschreibung

- stabile Stahlblechkonstruktion und bewährte Technik
- leichtgängiger, zweireihiger Kugelkranz für gute Manövrierbarkeit

Radserie 08Rc

- Vollgummireifen schwarz (Shore A 80)
- Stahlblechfelge verzinkt-passiviert
- Rollenlager
- große Rädervielfalt für unterschiedliche Einsatzzwecke, siehe Kapitel »Räder«

Technical description

- stable sheet steel design and proven technology
- easy running double ball bearing for good manoeuvrability

Wheel series 08Rc

- solid rubber tyre black (Shore A 80)
- sheet steel metal rim zinc passivated
- roller bearing
- wide choice of wheels for different areas of application, see chapter »Wheels«

441a Lenkrolle / Swivel castor

441h Lenkrolle mit Totalfeststeller nachlaufend / Swivel castor with total brake mounted behind

Michelrollen
Furniture castors

Apparaterollen
Apparatus castors

Medizinisch-Technische Rollen
Medical equipment castors

Transportgeräterollen
Transport appliance castors

Edelstahlrollen
Stainless steel castors

Schwerlastrollen
Heavy duty castors

Bäckerrollen
Bakery castors

Räder
Wheels

Zubehör
Accessories



441a 08R080c ZLD-5	80	22	110	35	12,5	70	•
441a 08R100c ZLD-5	100	22	127	39	12,5	90	•
441a 08R125c ZLD-5	125	28	149	35	12,5	120	•
441a 08R160c ZLD-5	160	30	189	57	16,5	200	•
441a 08R200c ZLD-5	200	30	227	62	16,5	230	•
441h 08R080c ZLD-5	80	22	110	35	12,5	70	•
441h 08R100c ZLD-5	100	22	127	39	12,5	90	•
441h 08R125c ZLD-5	125	28	149	35	12,5	120	•
441h 08R160c ZLD-5	160	30	189	57	16,5	200	•
441h 08R200c ZLD-5	200	30	227	62	16,5	230	•

• Artikel auf Anfrage / product on request

Technische Beschreibung

- stabile Stahlblechkonstruktion und bewährte Technik
- leichtgängiger, zweireihiger Kugelkranz für gute Manövrierbarkeit
- Dichtring im Gabelkopf

Radserie 08Rc

- Vollgummireifen schwarz (Shore A 80)
- Stahlblechfelge verzinkt-passiviert
- Rollenlager

Technical description

- Stable sheet steel design and proven technology
- Easy running double ball bearing for good manoeuvrability
- Sealing ring in swivel head

Wheel series 08Rc

- solid rubber tyre black (Shore A 80)
- sheet steel metal rim zinc passivated
- roller bearing

441a Lenkrolle / Swivel castor

441h Lenkrolle mit Totalfeststeller nachlaufend / Swivel castor with total brake mounted behind

441i Lenkrolle mit Totalfeststeller vorlaufend / Swivel castor with total brake mounted in front

439a Bockrolle / Fixed castor



441a 07R080c ZPH	80	20	107	34	104x80	9	72x52/80x60	50	
441a 07R100c ZPH	100	22	128	34	104x80	9	72x52/80x60	70	
441a 07R125c ZPH	125	22	152	32	104x80	9	72x52/80x60	100	
441a 07R125c ZPI	125	25	156	37	115x85	9	80x55/60	100	
441a 07R160c ZPK	160	28	197	48	138x109	11	105x75/80	135	
441a 07R200c ZPK	200	31	237	58	138x109	11	105x75/80	205	



441h 07R080c ZPH	80	20	107	34	104x80	9	72x52/80x60	50	
441h 07R100c ZPH	100	22	128	34	104x80	9	72x52/80x60	70	
441h 07R125c ZPH	125	22	152	32	104x80	9	72x52/80x60	100	
441h 07R125c ZPI	125	25	156	37	115x85	9	80x55/60	110	
441h 07R160c ZPK	160	28	197	48	138x109	11	105x75/80	135	
441h 07R200c ZPK	200	31	237	58	138x109	11	105x75/80	205	



441i 07R160c ZPK	160	28	197	48	138x109	11	105x75/80	135	
441i 07R200c ZPK	200	31	237	58	138x109	11	105x75/80	205	



439a 07R080c ZPG	80	20	107		104x84	9	72x52/80x60	50	
439a 07R100c ZPG	100	22	128		104x84	9	72x52/80x60	70	
439a 07R125c ZPG	125	22	152		104x84	9	72x52/80x60	100	
439a 07R125c ZPI	125	25	156		115x85	9	80x55/60	100	
439a 07R160c ZPK	160	28	197		138x109	11	105x75/80	135	
439a 07R200c ZPK	200	31	237		138x109	11	105x75/80	205	

Technische Beschreibung

- stabile Stahlblechkonstruktion und bewährte Technik
- leichtgängiger, zweireihiger Kugelkranz für gute Manövrierbarkeit
- für Serie 441a ab Raddurchmesser 160 mm steht optional eine anschraubbare Lenksperrung »ASLaZ« zur Verfügung (separat bestellbar, siehe Kapitel »Zubehör«)

Radserie 07Rc

- Vollgummireifen schwarz (Shore A 80)
- Kunststoff-Radkörper
- Rollenlager
- große Rädervielfalt für unterschiedliche Einsatzzwecke, siehe Kapitel »Räder«

Technical description

- stable sheet steel design and proven technology
- easy running double ball bearing for good manoeuvrability
- for series 441a starting from wheel diameter 160 mm a screw-on directional lock »ASLaZ« is available optionally (can be ordered separately, see chapter »Accessories«)

Wheel series 07Rc

- solid rubber tyre black (Shore A 80)
- plastic wheel centre
- roller bearing
- wide choice of wheels for different areas of application, see chapter »Wheels«

441a Lenkrolle / Swivel castor

441h Lenkrolle mit Totalfeststeller nachlaufend / Swivel castor with total brake mounted behind

439a Bockrolle / Fixed castor

Möbelrollen
Furniture castors

Apparaterollen
Apparatus castors

Medizinisch-Technische Rollen
Medical equipment castors

Transportgeräterollen
Transport appliance castors

Edelstahlrollen
Stainless steel castors

Schwerlastrollen
Heavy duty castors

Bäckerrollen
Bakery castors

Räder
Wheels

Zubehör
Accessories



441a 07R080c ZPH-5	80	22	112	35	100x80	9	80x60	60	•	
441a 07R100c ZPH-5	100	22	128	39	100x80	9	80x60	75	•	
441a 07R125c ZPH-5	125	28	152	35	100x80	9	80x60	120	•	
441a 07R160c ZPK-5	160	30	193	57	140x110	11	105x80	140	•	
441a 07R200c ZPK-5	200	30	232	62	140x110	11	105x80	200	•	
441h 07R080c ZPH-5	80	22	112	35	100x80	9	80x60	60	•	
441h 07R100c ZPH-5	100	22	128	39	100x80	9	80x60	75	•	
441h 07R125c ZPH-5	125	28	152	35	100x80	9	80x60	120	•	
441h 07R160c ZPK-5	160	30	193	57	140x110	11	105x80	140	•	
441h 07R200c ZPK-5	200	30	232	62	140x110	11	105x80	200	•	
439a 07R080c ZPG-5	80	22	112		100x84	9	80x60	60	•	
439a 07R100c ZPG-5	100	22	128		100x84	9	80x60	75	•	
439a 07R125c ZPG-5	125	28	152		100x84	9	80x60	120	•	
439a 07R160c ZPK-5	160	30	193		146x107	11	105x80	140	•	
439a 07R200c ZPK-5	200	30	232		146x107	11	105x80	200	•	

• Artikel auf Anfrage / product on request

Technische Beschreibung

- stabile Stahlblechkonstruktion und bewährte Technik
- leichtgängiger, zweireihiger Kugelkranz für gute Manövrierbarkeit
- Dichtring im Gabelkopf

Radserie 07Rc

- Vollgummireifen schwarz (Shore A 80)
- Kunststoff-Radkörper
- Rollenlager

Technical description

- Stable sheet steel design and proven technology
- Easy running double ball bearing for good manoeuvrability
- Sealing ring in swivel head







Wheel series 07Rc

- solid rubber tyre black (Shore A 80)
- plastic wheel centre
- roller bearing

441a Lenkrolle / Swivel castor

441h Lenkrolle mit Totalfeststeller nachlaufend / Swivel castor with total brake mounted behind



							
441a 07R080c ZLD	80	20	105,5	34	12,2	50	
441a 07R100c ZLD	100	22	128	34	12,2	70	
441a 07R125c ZLD	125	22	151	32	12,2	100	



							
441h 07R080c ZLD	80	20	105,5	34	12,2	50	
441h 07R100c ZLD	100	22	128	34	12,2	70	
441h 07R125c ZLD	125	22	151	32	12,2	100	

Technische Beschreibung

- stabile Stahlblechkonstruktion und bewährte Technik
- leichtgängiger, zweireihiger Kugelkranz für gute Manövrierbarkeit

Radserie 07Rc

- Vollgummireifen schwarz (Shore A 80)
- Kunststoff-Radkörper
- Rollenlager
- große Rädervielfalt für unterschiedliche Einsatzzwecke, siehe Kapitel »Räder«

Technical description

- stable sheet steel design and proven technology
- easy running double ball bearing for good manoeuvrability

Wheel series 07Rc

- solid rubber tyre black (Shore A 80)
- plastic wheel centre
- roller bearing
- wide choice of wheels for different areas of application, see chapter »Wheels«

441a Lenkrolle / Swivel castor

441h Lenkrolle mit Totalfeststeller nachlaufend / Swivel castor with total brake mounted behind

Michelrollen
Furniture castors

Apparaterollen
Apparatus castors

Medizinisch-Technische Rollen
Medical equipment castors

Transportgeräterollen
Transport appliance castors

Edelstahlrollen
Stainless steel castors

Schwerlastrollen
Heavy duty castors

Bäckerrollen
Bakery castors

Räder
Wheels

Zubehör
Accessories



441a 07R080c ZLD-5	80	22	110	35	12,5	60	•
441a 07R100c ZLD-5	100	22	127	39	12,5	75	•
441a 07R125c ZLD-5	125	28	149	35	12,5	120	•
441a 07R160c ZLD-5	160	30	189	57	16,5	140	•
441a 07R200c ZLD-5	200	30	227	62	16,5	200	•
441h 07R080c ZLD-5	80	22	110	35	12,5	60	•
441h 07R100c ZLD-5	100	22	127	39	12,5	75	•
441h 07R125c ZLD-5	125	28	149	35	12,5	120	•
441h 07R160c ZLD-5	160	30	189	57	16,5	140	•
441h 07R200c ZLD-5	200	30	227	62	16,5	200	•

• Artikel auf Anfrage / product on request

Technische Beschreibung

- stabile Stahlblechkonstruktion und bewährte Technik
- leichtgängiger, zweireihiger Kugelkranz für gute Manövrierbarkeit
- Dichtring im Gabelkopf

Radserie 07Rc

- Vollgummireifen schwarz (Shore A 80)
- Kunststoff-Radkörper
- Rollenlager

Technical description

- Stable sheet steel design and proven technology
- Easy running double ball bearing for good manoeuvrability
- Sealing ring in swivel head

Wheel series 07Rc

- solid rubber tyre black (Shore A 80)
- plastic wheel centre
- roller bearing

441a Lenkrolle / Swivel castor

441h Lenkrolle mit Totalfeststeller nachlaufend / Swivel castor with total brake mounted behind

441i Lenkrolle mit Totalfeststeller vorlaufend / Swivel castor with total brake mounted in front



441a 00R065p ZPH	65	33	92	37,5	104x80	9	72x52/80x60	100	
441a 00R080p ZPH	80	33	107	34	104x80	9	72x52/80x60	100	
441a 00R100p ZPH	100	32	128	34	104x80	9	72x52/80x60	125	
441a 00R100p ZPI	100	40	132	38	115x85	9	80x55/60	150	
441a 00R125p ZPH	125	32	152	32	104x80	9	72x52/80x60	125	
441a 00R125p ZPI	125	40	156	37	115x85	9	80x55/60	150	
441a 00R150p ZPK	150	45	192	48	138x109	11	105x75/80	225	
441a 00R160p ZPK	160	42	197	48	138x109	11	105x75/80	225	
441a 00R200p ZPK	200	50	237	58	138x109	11	105x75/80	300	



441h 00R065p ZPH	65	33	92	37,5	104x80	9	72x52/80x60	100	
441h 00R080p ZPH	80	33	107	34	104x80	9	72x52/80x60	100	
441h 00R100p ZPH	100	35	128	34	104x80	9	72x52/80x60	125	
441h 00R100p ZPI	100	40	132	38	115x85	9	80x55/60	150	
441h 00R125p ZPH	125	32	152	32	104x80	9	72x52/80x60	125	
441h 00R125p ZPI	125	40	156	37	115x85	9	80x55/60	150	



441i 00R150p ZPK	150	45	192	48	138x109	11	105x75/80	225	
441i 00R200p ZPK	200	50	237	58	138x109	11	105x75/80	300	

Technische Beschreibung

- stabile Stahlblechkonstruktion und bewährte Technik
- leichtgängiger, zweireihiger Kugelkranz für gute Manövrierbarkeit
- für Serie 441a ab Raddurchmesser 150 mm steht optional eine anschraubbare Lenksperr «ASLaZ» zur Verfügung (separat bestellbar, siehe Kapitel »Zubehör«)

Radserie 00Rp

- Polyamid weiß
- Rollenlager
- große Rädervielfalt für unterschiedliche Einsatzzwecke, siehe Kapitel »Räder«

Technical description

- stable sheet steel design and proven technology
- easy running double ball bearing for good manoeuvrability
- for series 441a starting from wheel diameter 150 mm a screw-on directional lock »ASLaZ« is available optionally (can be ordered separately, see chapter »Accessories«)

Wheel series 00Rp

- polyamide white
- roller bearing
- wide choice of wheels for different areas of application, see chapter »Wheels«

439a Bockrolle / Fixed castor



439a 00R065p ZPG	65	33	92	104x84	9	72x52/80x60	100	
439a 00R080p ZPG	80	33	107	104x84	9	72x52/80x60	100	
439a 00R100p ZPG	100	35	128	104x84	9	72x52/80x60	125	
439a 00R100p ZPI	100	40	132	115x85	9	80x55/60	150	
439a 00R125p ZPG	125	32	152	104x84	9	72x52/80x60	125	
439a 00R125p ZPI	125	40	156	115x85	9	80x55/60	150	
439a 00R150p ZPK	150	45	192	138x109	11	105x75/80	225	
439a 00R160p ZPK	160	42	197	138x109	11	105x75/80	225	
439a 00R200p ZPK	200	50	237	138x109	11	105x75/80	300	

Möbelrollen
Furniture castors

Apparaterollen
Apparatus castors

Medizinisch-Technische Rollen
Medical equipment castors

Transportgeräterollen
Transport appliance castors

Edelstahlrollen
Stainless steel castors

Schwerlastrollen
Heavy duty castors

Bäckerrollen
Bakery castors

Räder
Wheels

Zubehör
Accessories

Technische Beschreibung

- stabile Stahlblechkonstruktion und bewährte Technik
- verzinkt-passiviert

Radserie 00Rp

- Polyamid weiß
- Rollenlager
- große Rädervielfalt für unterschiedliche Einsatzzwecke, siehe Kapitel »Räder«

Technical description

- stable sheet steel design and proven technology
- zinc passivated













Wheel series 00Rp

- polyamide white
- roller bearing
- wide choice of wheels for different areas of application, see chapter »Wheels«

441a Lenkrolle / Swivel castor

441h Lenkrolle mit Totalfeststeller nachlaufend / Swivel castor with total brake mounted behind



							
441a 00R065p ZLD	65	33	90,5	37,5	12,2	100	•
441a 00R080p ZLD	80	33	105,5	34	12,2	100	
441a 00R100p ZLD	100	35	128	34	12,2	125	
441a 00R125p ZLD	125	32	151	32	12,2	125	
							
441h 00R065p ZLD	65	33	90,5	37,5	12,2	100	•
441h 00R080p ZLD	80	33	105,5	34	12,2	100	
441h 00R100p ZLD	100	35	128	34	12,2	125	
441h 00R125p ZLD	125	32	151	32	12,2	125	

• Artikel auf Anfrage / product on request

Technische Beschreibung

- stabile Stahlblechkonstruktion und bewährte Technik
- leichtgängiger, zweireihiger Kugelkranz für gute Manövrierbarkeit

Radserie 00Rp

- Polyamid weiß
- Rollenlager
- große Rädervielfalt für unterschiedliche Einsatzzwecke, siehe Kapitel »Räder«

Technical description

- stable sheet steel design and proven technology
- easy running double ball bearing for good manoeuvrability

Wheel series 00Rp

- polyamide white
- roller bearing
- wide choice of wheels for different areas of application, see chapter »Wheels«

441a Lenkrolle / Swivel castor

441h Lenkrolle mit Totalfeststeller nachlaufend / Swivel castor with total brake mounted behind

439a Bockrolle / Fixed castor



441a 14R100d ZPH	100	26	128	34	104x80	9	72x52/80x60	140		
441a 14R125d ZPH	125	27	152	32	104x80	9	72x52/80x60	140		

441h 14R100d ZPH	100	26	128	34	104x80	9	72x52/80x60	140		
441h 14R125d ZPH	125	27	152	32	104x80	9	72x52/80x60	140		

439a 14R100d ZPG	100	26	128		104x84	9	72x52/80x60	140		
439a 14R125d ZPG	125	27	152		104x84	9	72x52/80x60	140		

Möbelrollen / Furniture castors
 Apparaterollen / Apparatus castors
 Medizinisch-Technische Rollen / Medical equipment castors
Transportgeräterollen / Transport appliance castors
 Edelstahlrollen / Stainless steel castors
 Schwerlastrollen / Heavy duty castors
 Backerrollen / Bakery castors
 Räder / Wheels
 Zubehör / Accessories

Technische Beschreibung

- stabile Stahlblechkonstruktion und bewährte Technik
- leichtgängiger, zweireihiger Kugelkranz für gute Manövrierbarkeit

Radserie 14Rd

- Elastik-Vollgummireifen aufvulkanisiert blau (Shore A 70)
- Kunststoff-Radkörper schwarz
- Rollenlager
- große Rädervielfalt für unterschiedliche Einsatzzwecke, siehe Kapitel »Räder«

Technical description

- stable sheet steel design and proven technology
- easy running double ball bearing for good manoeuvrability







Wheel series 14Rd

- elastic solid rubber tyre blue (Shore A 70)
- vulcanised firmly on plastic wheel centre black
- roller bearing
- wide choice of wheels for different areas of application, see chapter »Wheels«







441a Lenkrolle / Swivel castor

441h Lenkrolle mit Totalfeststeller nachlaufend / Swivel castor with total brake mounted behind



							
441a 14R100d ZLD	100	26	128	34	12,2	140	
441a 14R125d ZLD	125	27	151	32	12,2	140	



							
441h 14R100d ZLD	100	26	128	34	12,2	140	
441h 14R125d ZLD	125	27	151	32	12,2	140	

Technische Beschreibung

- stabile Stahlblechkonstruktion und bewährte Technik
- leichtgängiger, zweireihiger Kugelkranz für gute Manövrierbarkeit

Radserie 14Rd

- Elastik-Vollgummireifen aufvulkanisiert blau (Shore A 70)
- Kunststoff-Radkörper schwarz
- Rollenlager
- große Rädervielfalt für unterschiedliche Einsatzzwecke, siehe Kapitel »Räder«

Technical description

- stable sheet steel design and proven technology
- easy running double ball bearing for good manoeuvrability

Wheel series 14Rd

- elastic solid rubber tyre blue (Shore A 70)
- vulcanised firmly on plastic wheel centre black
- roller bearing
- wide choice of wheels for different areas of application, see chapter »Wheels«

478a Lenkrolle / Swivel castor

478i Lenkrolle mit Totalfeststeller vorlaufend / Swivel castor with total brake mounted in front

477a Bockrolle / Fixed castor

Michelrollen
Furniture castors

Apparaterollen
Apparatus castors

Medizinisch-Technische Rollen
Medical equipment castors

Transportgeräterollen
Transport appliance castors

Edelstahlrollen
Stainless steel castors

Schwerlastrollen
Heavy duty castors

Bäckerrollen
Bakery castors

Räder
Wheels

Zubehör
Accessories



478a 18K100v ZPK	100	40	148	48	138x109	11	105x75/80	275	
478a 18K125v ZPK	125	40	178	48	138x109	11	105x75/80	350	
478a 18K150v ZPK	150	50	205	48	138x109	11	105x75/80	600	
478a 18K200v ZPK	200	50	248	58	138x109	11	105x75/80	600	

478i 18K125v ZPK	125	40	178	48	138x109	11	105x75/80	350	
478i 18K150v ZPK	150	50	205	48	138x109	11	105x75/80	600	
478i 18K200v ZPK	200	50	248	58	138x109	11	105x75/80	600	

477a 18K100v ZPK	100	40	148		138x109	11	105x75/80	275	
477a 18K125v ZPK	125	40	178		138x109	11	105x75/80	350	
477a 18K150v ZPK	150	50	205		138x109	11	105x75/80	600	
477a 18K200v ZPK	200	50	248		138x109	11	105x75/80	600	

Technische Beschreibung

- schweres Stahlblechgehäuse
- verzinkt-passiviert
- spezieller Gabelkopf mit zweireihigem Kugellauf
- dreifach mit der Gabel verschraubt
- wartungsfrei durch Dauerfettfüllung im Gabelkopf
- staub- und spritzwassergeschützt durch geschlossenen Gabelkopf
- für Serie 478a steht optional eine anschraubbare Lenksperre »ASL 478« zur Verfügung (separat bestellbar, siehe Kapitel »Zubehör«)

Radserie 18Kv

- Polyurethan-Bandage rotorange (Shore A 95)
- Guss-Radkörper
- Präzisionskugellager

Technical description

- heavy sheet steel housing zinc passivated
- special swivel head with double ball race
- triple-bolted to fork head
- maintenance-free permanently grease filled in fork head, zinc passivated
- protected against dust and water by sealed swivel head
- for series 478a a screw-on directional lock »ASL 478« is available optionally (can be ordered separately, see chapter »Accessories«)

Wheel series 18Kv

- Polyurethane tyre red-orange (Shore A 95)
- bonded on cast wheel centre
- precision ball bearing

478a Lenkrolle / Swivel castor

478i Lenkrolle mit Totalfeststeller vorlaufend / Swivel castor with total brake mounted in front

477a Bockrolle / Fixed castor



478a 0SR100p ZPK	100	45	148	48	138x109	11	105x75/80	500	
478a 0SR125p ZPK	125	45	178	48	138x109	11	105x75/80	600	
478a 0SR150p ZPK	150	45	205	48	138x109	11	105x75/80	600	
478a 0SR200p ZPK	200	50	248	58	138x109	11	105x75/80	600	



478i 0SR125p ZPK	125	45	178	48	138x109	11	105x75/80	600	
478i 0SR150p ZPK	150	45	205	48	138x109	11	105x75/80	600	
478i 0SR200p ZPK	200	50	248	58	138x109	11	105x75/80	600	



477a 0SR100p ZPK	100	45	148	138x109	11	105x75/80	500	
477a 0SR125p ZPK	125	45	178	138x109	11	105x75/80	600	
477a 0SR150p ZPK	150	45	205	138x109	11	105x75/80	600	
477a 0SR200p ZPK	200	50	248	138x109	11	105x75/80	600	

Technische Beschreibung

- schweres Stahlblechgehäuse
- verzinkt-passiviert
- spezieller Gabelkopf mit zweireihigem Kugellauf
- dreifach mit der Gabel verschraubt
- wartungsfrei durch Dauerfettfüllung im Gabelkopf
- staub- und spritzwassergeschützt durch geschlossenen Gabelkopf
- für Serie 478a steht optional eine anschaubare Lenksperre »ASL 478« zur Verfügung (separat bestellbar, siehe Kapitel »Zubehör«)

Radserie 00Rp

- Polyamid weiß
- Rollenlager

Technical description

- heavy sheet steel housing zinc passivated
- special swivel head with double ball race
- triple-bolted to fork head
- maintenance-free permanently grease filled in fork head, zinc passivated
- protected against dust and water by sealed swivel head
- for series 478a a screw-on directional lock »ASL 478« is available optionally (can be ordered separately, see chapter »Accessories«)

Wheel series 00Rp

- polyamide white
- roller bearing

Edelstahlrollen

Stainless steel castors

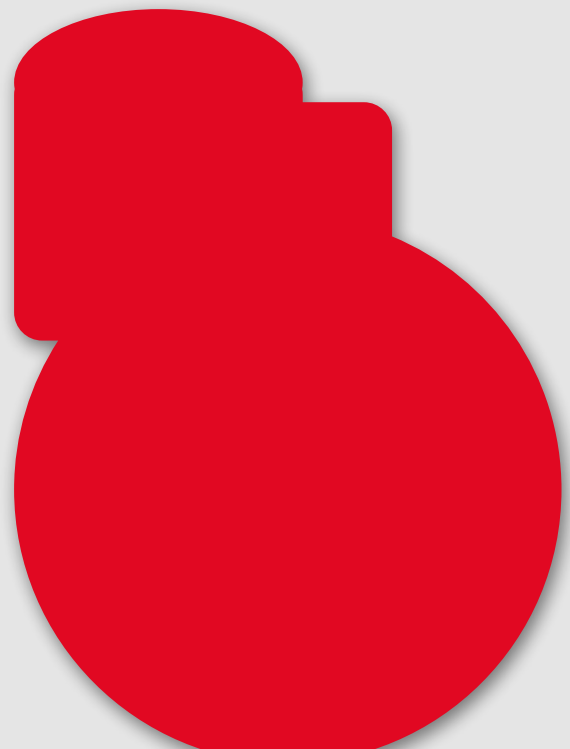

394a Lenkrolle / Swivel castor

394h Lenkrolle mit Totalfeststeller nachlaufend / Swivel castor with total brake mounted behind

Möbelrollen / Furniture castors
 Apparaterollen / Apparatus castors
 Medizinisch-Technische Rollen / Medical equipment castors
 Transportgeräterollen / Transport appliance castors
 Schwerlastrollen / Heavy duty castors
 Backerrollen / Bakery castors
 Räder / Wheels
 Zubehör / Accessories



394a 29G100r EPD	100	30	138	42	77x67	8,5	61x51/57x48	100		
394a 29G125r EPD	125	30	162,5	44	77x67	8,5	61x51/57x48	100		

394h 29G100r EPD	100	30	138	42	77x67	8,5	61x51/57x48	100		
394h 29G125r EPD	125	30	162,5	44	77x67	8,5	61x51/57x48	100		

Technische Beschreibung

- Edelstahlgehäuse
- Schwenklager mit zweireihigem Kugellauf
- Kugeln aus Edelstahl
- Dichtring

Radserie 29Gr

- thermoplastische Elastomer-Bandage (TPE), eisengrau RAL 7011 (Shore A 80)
- Kunststoff-Radkörper silbergrau RAL 7001 ohne Fadenschutz
- Gleitlager
- Kontaktverfärbung auf unversiegelten Böden möglich!

Technical description

- stainless steel housing
- swivel bearing with double ball race
- ball bearings of stainless steel
- sealing ring

Wheel series 29Gr







- thermoplastic elastomer tyre (TPE) iron grey RAL 7011 (Shore A 80)
- plastic wheel centre silver grey RAL7001
- without thread guard
- plain bearing
- Contact discoloration on unsealed grounds possible!









394a Lenkrolle / Swivel castor

394h Lenkrolle mit Totalfeststeller nachlaufend / Swivel castor with total brake mounted behind



							
394a 29G100r ELD	100	30	131,5	42	12,2	100	
394a 29G125r ELD	125	30	156	44	12,2	100	



							
394h 29G100r ELD	100	30	131,5	42	12,2	100	
394h 29G125r ELD	125	30	156	44	12,2	100	

Technische Beschreibung

- Edelstahlgehäuse
- Schwenklager mit zweireihigem Kugellauf
- Kugeln aus Edelstahl
- Dichtring
- auch mit Rückenloch LC (10,2 mm) lieferbar

Radserie 29Gr

- thermoplastische Elastomer-Bandage (TPE), eisengrau RAL 7011 (Shore A 80)
- Kunststoff-Radkörper silbergrau RAL 7001 ohne Fadenschutz
- Gleitlager
- Kontaktverfärbung auf unversiegelten Böden möglich!

Technical description

- stainless steel housing
- swivel bearing with double ball race
- ball bearings of stainless steel
- sealing ring
- also available with bolt hole LC (10,2 mm)

Wheel series 29Gr

- thermoplastic elastomer tyre (TPE) iron grey RAL 7011 (Shore A 80)
- plastic wheel centre silver grey RAL7001
- without thread guard
- plain bearing
- Contact discoloration on unsealed grounds possible!

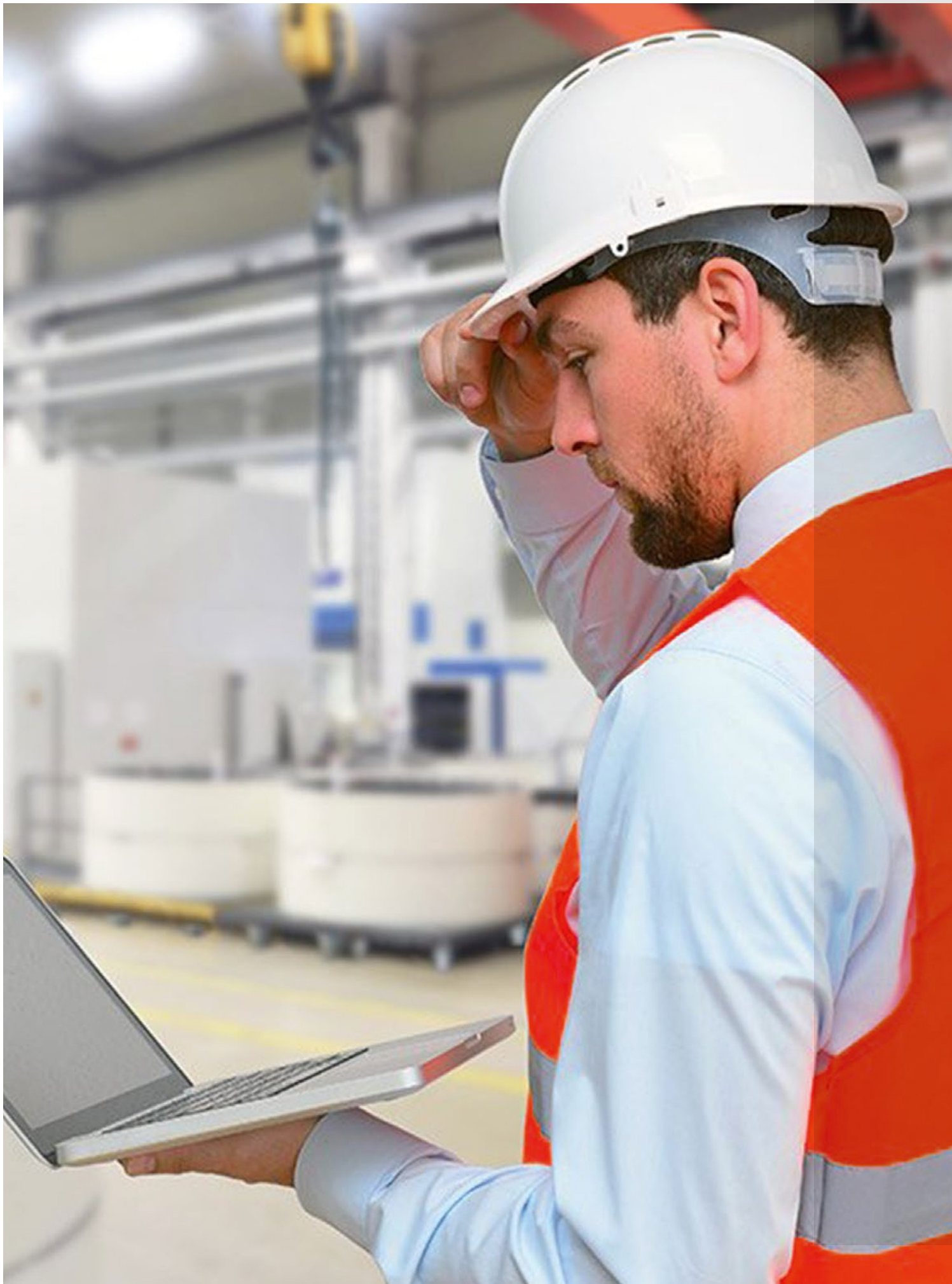

Schwerlastrollen

Heavy duty castors



505a Lenkrolle / Swivel castor

504a Bockrolle / Fixed castor

Möbelrollen
Furniture castors

Apparaturrollen
Apparatus castors

Medizinisch-Technische Rollen
Medical equipment castors

Transportgeräterollen
Transport appliance castors

Edelstahlrollen
Stainless steel castors

Schwerlastrollen
Heavy duty castors

Bäckerrollen
Bakery castors

Räder
Wheels

Zubehör
Accessories



505a 0SK085p ZPS	85	85	125	57	190x170	16,5	150x135	1200	●



504a 0SK085p ZPS	85	85	125		190x170	16,5	150x135	1200	●



505a 18K085v ZPS	85	85	125	57	190x170	16,5	150x135	700	●



504a 18K085v ZPS	85	85	125		190x170	16,5	150x135	700	●

● Artikel auf Anfrage / product on request

Technische Beschreibung

- schwere Stahlschweißkonstruktion mit Spezial-Drehkranz
- verzinkt-passiviert
- geprägte Kugelbahn oben, Kegelrollenlager unten
- Fettfüllung und Schmiemippel im Gabelkopf

Radserie 0SKp

- Polyamid weiß
- Präzisionskugellager
- schwere Ausführung mit hoher Tragfähigkeit

Radserie 18Kv

- Polyurethan-Bandage rotorange (Shore A 95)
- Guss-Radkörper
- Präzisionskugellager

Technical description

- heavy steel welded construction with special turntable
- zinc passivated
- pressed ball track above, with tapered roller bearing below
- grease filling and grease nipple in fork head

Wheel series 0SKp

- polyamide white
- precision ball bearing
- heavy execution

Wheel series 18Kv

- Polyurethane tyre red-orange (Shore A 95)
- bonded on cast wheel centre
- precision ball bearing











510a Bockrolle / Fixed castor









510i Lenkrolle mit Totalfeststeller vorlaufend / Swivel castor with total brake mounted in front

509a Bockrolle / Fixed castor









									
510a 18K125v ZPS	125	40	192,5	50	190x110	17	150x75	350	•
510a 18K150v ZPS	150	50	220	58	190x110	17	150x75	700	•
510a 18K200v ZPS	200	50	265	68	190x110	17	150x75	950	•
510a 18K250v ZPS	250	50	315	80	190x110	17	150x75	1000	•



									
510i 18K125v ZPS	125	40	192,5	50	190x110	17	150x75	350	•
510i 18K150v ZPS	150	50	220	58	190x110	17	150x75	700	•
510i 18K200v ZPS	200	50	265	68	190x110	17	150x75	950	•
510i 18K250v ZPS	250	50	315	80	190x110	17	150x75	1000	•



									
509a 18K125v ZPS	125	40	192,5		190x110	17	150x75	350	•
509a 18K150v ZPS	150	50	220		190x110	17	150x75	700	•
509a 18K200v ZPS	200	50	265		190x110	17	150x75	950	•
509a 18K250v ZPS	250	50	315		190x110	17	150x75	1000	•

• Artikel auf Anfrage / product on request

Technische Beschreibung

- schwere Stahlschweißkonstruktion
- verzinkt-passiviert
- Spezial-Drehkranz mit geprägter Kugelbahn oben und Kegelrollenlager unten
- Fettfüllung und Schmiernippel im Gabelkopf

Radserie 18Kv

- Polyurethan-Bandage rotorange (Shore A 95)
- Guss-Radkörper
- Präzisionskugellager

Technical description

- heavy steel welded construction with special turntable
- zinc passivated
- pressed ball track above, with tapered roller bearing below
- grease filling and grease nipple in fork head

Wheel series 18Kv

- Polyurethane tyre red-orange (Shore A 95)
- bonded on cast wheel centre
- precision ball bearing

- TSH** Lenkrolle / Swivel castor
- TSH-F** Lenkrolle mit Totalfeststeller vorlaufend / Swivel castor with total brake mounted in front
- TFH** Bockrolle / Fixed castor

Möbelrollen / Furniture castors
 Apparaterollen / Apparatus castors
 Medizinisch-Technische Rollen / Medical equipment castors
 Transportgeräterollen / Transport appliance castors
 Edelstahlrollen / Stainless steel castors
Schwerlastrollen / Heavy duty castors
 Backerrollen / Bakery castors
 Räder / Wheels
 Zubehör / Accessories



TSH 100 PT2H	100	38	152	52	150x110	12/10	120/105x60/75	340	
TSH 125 PT2H	125	38	177	55,5	150x110	12/10	120/105x60/75	425	
TSH 150 PT2H	150	38	202	62	150x110	12/10	120/105x60/75	730	•
TSH 200 PT2H	200	45	252	66	150x110	12/10	120/105x60/75	1100	•
TSH 250 PT2H	250	45	303	82	150x110	12/10	120/105x60/75	1200	•
TSH 300 PT2H	300	45	353	95	150x110	12/10	120/105x60/75	1400	•



TSH 150 PT2HF	150	38	202	62	150x110	12/10	120/105x60/75	730	•
TSH 200 PT2HF	200	45	252	66	150x110	12/10	120/105x60/75	1100	•



TFH 100 PT2H	100	38	152		150x115	12/10	120/105x60/75	340	
TFH 125 PT2H	125	38	177		150x115	12/10	120/105x60/75	425	
TFH 150 PT2H	150	38	202		150x115	12/10	120/105x60/75	730	•
TFH 200 PT2H	200	45	252		150x115	12/10	120/105x60/75	1100	•
TFH 250 PT2H	250	45	303		150x115	12/10	120/105x60/75	1200	•
TFH 300 PT2H	300	45	353		150x115	12/10	120/105x60/75	1400	•

• Artikel auf Anfrage / product on request

Technische Beschreibung

- schwere Stahlschweißkonstruktion
- verzinkt-passiviert
- Spezial-Drehkranz
- Fettfüllung und Schmiemippel im Gabelkopf

Radserie PT

- Polyurethan-Bandage (Shore A 92-97)
- Guss-Radkörper
- Präzisionskugellager

Technical description

- heavy steel welded construction
- zinc passivated
- swivel castor with special turntable
- grease filling and grease nipple in fork head

Wheel series PT

- Polyurethane tyre (Shore A 92-97)
- Cast iron centre
- Precision ball bearing



TSH Lenkrolle / Swivel castor

TSH-F Lenkrolle mit Totalfeststeller vorlaufend / Swivel castor with total brake mounted in front

TFH Bockrolle / Fixed castor



TSH 150 NY2H	150	50	202	62	150x110	12/10	120/105x60/75	800
TSH 200 NY2H	200	50	252	66	150x110	12/10	120/105x60/75	1500
TSH 250 NY2H	250	60	303	82	150x110	12/10	120/105x60/75	1500



TSH 150 NY2HF	150	50	202	62	150x110	12/10	120/105x60/75	800
TSH 200 NY2HF	200	50	252	66	150x110	12/10	120/105x60/75	1500



TFH 150 NY2H	150	50	202	150x115	12/10	120/105x60/75	800
TFH 200 NY2H	200	50	252	150x115	12/10	120/105x60/75	1500
TFH 250 NY2H	250	60	303	150x115	12/10	120/105x60/75	1500

Technische Beschreibung

- schwere Stahlschweißkonstruktion
- verzinkt-passiviert
- Spezial-Drehkranz
- Fettfüllung und Schmiemippel im Gabelkopf

Radserie NY

- Nylon-Rad weiß
- Präzisionskugellager

Technical description

- heavy steel welded construction
- zinc passivated
- swivel castor with special turntable
- grease filling and grease nipple in fork head

Wheel series NY

- nylon wheel white
- precision ball bearing

525a Lenkrolle / Swivel castor

525i Lenkrolle mit Totalfeststeller vorlaufend / Swivel castor with total brake mounted in front

526a Bockrolle / Fixed castor

Michelrollen
Furniture castors

Apparaterollen
Apparatus castors

Medizinisch-Technische Rollen
Medical equipment castors

Transportgeräterollen
Transport appliance castors

Edelstahlrollen
Stainless steel castors

Schwerlastrollen
Heavy duty castors

Bäckerrollen
Bakery castors

Räder
Wheels

Zubehör
Accessories



525a 18K125v ZPS		125	2x40	192,5	50	190x170	17	150x135	700	●
525a 18K150v ZPS		150	2x50	220	58	190x170	17	150x135	1300	●
525a 18K200v ZPS		200	2x50	265	68	190x170	17	150x135	1450	●
525a 18K250v ZPS		250	2x50	315	80	190x170	17	150x135	1500	●
525i 18K125v ZPS		125	2x40	192,5	50	190x170	17	150x135	700	●
525i 18K150v ZPS		150	2x50	220	58	190x170	17	150x135	1300	●
525i 18K200v ZPS		200	2x50	265	68	190x170	17	150x135	1450	●
525i 18K250v ZPS		250	2x50	315	80	190x170	17	150x135	1500	●
526a 18K125v ZPS		125	2x40	192,5		190x170	17	150x135	700	●
526a 18K150v ZPS		150	2x50	220		190x170	17	150x135	1300	●
526a 18K200v ZPS		200	2x50	265		190x170	17	150x135	1450	●
526a 18K250v ZPS		250	2x50	315		190x170	17	150x135	1500	●

● Artikel auf Anfrage / product on request

Technische Beschreibung

- schwere Stahlschweißkonstruktion
- verzinkt-passiviert
- Spezial-Drehkranz mit geprägter Kugelbahn oben und Kegelrollenlager unten
- Fettfüllung und Schmiernippel im Gabelkopf

Radserie 18Kv

- Polyurethan-Bandage rotorange (Shore A 95)
- Guss-Radkörper
- Präzisionskugellager

Technical description

- heavy steel welded construction with special turntable
- zinc passivated
- pressed ball track above, with tapered roller bearing below
- grease filling and grease nipple in fork head

Wheel series 18Kv

- Polyurethane tyre red-orange (Shore A 95)
- bonded on cast wheel centre
- precision ball bearing



2SH Lenkrolle / Swivel castor

2FH Bockrolle / Fixed castor



2SH 125 PT2H	125	2x38	177	62,5	150x110	12/10	120/105x60/75	720	
2SH 150 PT2H	150	2x38	202	65	150x110	12/10	120/105x60/75	1240	•
2SH 200 PT2H	200	2x45	252	70	150x110	12/10	120/105x60/75	1500	•



2FH 150 PT2H	150	2x38	202		150x175	12/10	120/105x60/75	1240	•
2FH 200 PT2H	200	2x45	252		150x175	12/10	120/105x60/75	1500	•



2SH 150 NY2H	150	2x50	202	65	150x110	12/10	120/105x60/75	1360	
2SH 200 NY2H	200	2x50	252	70	150x110	12/10	120/105x60/75	1500	



2FH 150 NY2H	150	2x50	202		150x175	12/10	120/105x60/75	1360	
2FH 200 NY2H	200	2x50	252		150x175	12/10	120/105x60/75	1500	

• Artikel auf Anfrage / product on request

Technische Beschreibung

- schwere Stahlschweißkonstruktion mit Spezial-Drehkranz
- verzinkt-passiviert
- Artikel 2SH...W mit Radfeststeller
- auch mit Richtungsfeststeller 2SH...D lieferbar

Radserie PT

- Polyurethan-Bandage (Shore A 92-97)
- Guss-Radkörper
- Präzisionskugellager

Radserie NY

- Nylon-Rad weiß
- Präzisionskugellager

Technical description

- heavy steel welded construction with special turntable
- zinc passivated
- article 2SH...W including wheel brake
- also available with directional lock 2SH...D

Wheel series PT

- Polyurethane tyre (Shore A 92-97)
- Cast iron centre
- Precision ball bearing

Wheel series NY

- nylon wheel white
- precision ball bearing

Räder Wheels



00 Räder / Wheels



00G025z	25	14	16,4	4	10	
00G030z	30	15	16,4	4	15	•
00G035x	35	18	21,5	5	25	
00G038z	38	17	18,2	6	20	
00G040z	40	18	21,5	6	30	
00G045x	45	18	21,5	6	35	
00G050x-06	50	18	21,5	6	50	
00G050x-08	50	18	21,5	8	50	
00G050z-06	50	18	21,5	6	50	
00G058z	58	29	31	10	100	
00G075x-08	75	23,5	27,5	8	50	•
00G100x-08	100	24,5	29,5	8	60	•
00R058x	58	29	31	10	100	



• Artikel auf Anfrage / product on request

Radserie 00Gz

- Polypropylen schwarz
- Gleitlager

Radserie 00Gx

- Polyamid schwarz
- Gleitlager

Radserie 00Rx

- Polyamid schwarz
- Rollenlager

Wheel series 00Gz

- polypropylene black
- plain bearing

Wheel series 00Gx

- polyamide black
- plain bearing

Wheel series 00Rx

- polyamide black
- roller bearing

OS Räder / Wheels

Möbelrollen
Furniture castors
Apparaterollen
Apparatus castors
Medizinisch-Technische Rollen
Medical equipment castors
Transportgeräterollen
Transport appliance castors
Edelstahlrollen
Stainless steel castors
Schwerlastrollen
Heavy duty castors
Bäckerrollen
Bakery castors
**Räder
Wheels**
Zubehör
Accessories



OSG100p	100	45	58	20	500	
OSG125p	125	45	58	20	600	
OSG150p	150	45	58	20	700	
OSG200p	200	50	58	20	1000	
OSR100p	100	45	58	20	500	
OSR125p	125	45	58	20	600	
OSR150p	150	45	58	20	700	
OSR200p	200	50	58	20	1000	
OSK085p	85	85	85	17	1200	
OSK100p	100	45	50	25	500	
OSK125p	125	45	50	25	600	
OSK150p	150	45	50	25	700	
OSK200p	200	50	55	25	1000	
OSK250p	250	50	55	25	1500	

Radserie OSGp

- Polyamid weiß
- Gleitlager
- schwere Ausführung mit hoher Tragfähigkeit

Radserie OSRp

- Polyamid weiß
- Rollenlager
- schwere Ausführung mit hoher Tragfähigkeit

Radserie OSKp

- Polyamid weiß
- Präzisionskugellager
- schwere Ausführung mit hoher Tragfähigkeit

Wheel series OSGp

- polyamide white
- plain bearing
- heavy execution

Wheel series OSRp

- polyamide white
- roller bearing
- heavy execution

Wheel series OSKp

- polyamide white
- precision ball bearing
- heavy execution

07 Räder / Wheels

08 Räder / Wheels



07R080c	80	20	35	12	50	
07R100c	100	22	35	12	70	
07R125c-35	125	22	35	12	100	
07R125c	125	25	48	15	100	
07R160c	160	28	58	20	135	
07R200c	200	31	58	20	205	



07R080c-5	80	22	39	11,5	60	•
07R100c-5	100	22	39	11,5	75	•
07R125c-5	125	28	49	14	120	•
07R160c-5	160	30	58	20	140	•
07R200c-5	200	30	58	20	200	•



08R080cZ	80	20	35	12	50	
08R100cZ	100	22	35	12	70	
08R125cZ-35Z	125	22	35	12	100	
08R125cZ	125	25	48	15	100	
08R160cZ	160	28	58	20	135	
08R200c-20Z	200	31	58	20	205	



08R080cZ-5	80	22	39	14	70	•
08R100cZ-5	100	22	39	14	90	•
08R125cZ-5	125	28	49	14	120	•
08R160cZ-5	160	30	58	20	200	•
08R200c-20Z-5	200	30	58	20	230	•

• Artikel auf Anfrage / product on request

Radserie 07Rc

- Vollgummireifen schwarz (Shore A 80)
- Kunststoff-Radkörper
- Rollenlager

Radserie 08Rc

- Vollgummireifen schwarz (Shore A 80)
- Stahlblechfelge verzinkt-passiviert
- Rollenlager

Wheel series 07Rc

- solid rubber tyre black (Shore A 80)
- plastic wheel centre
- roller bearing

Wheel series 08Rc

- solid rubber tyre black (Shore A 80)
- sheet steel metal rim zinc passivated
- roller bearing

29 Räder / Wheels



29G100r	100	30	35	12	100	
29G125r	125	30	35	12	100	

29K080r	80	30	36,5	8	80	
29K100r	100	30	36,5	8	100	
29K125r	125	32	36,5	8	100	
29K150r	150	32	36,5	8	120	
29K200r	200	32	36,5	8	120	

29K080a	80	30	36,5	8	80	
29K100a	100	30	36,5	8	100	
29K125a	125	32	36,5	8	100	
29K150a	150	32	36,5	8	120	

Radserie 29Gr

- thermoplastische Elastomer-Bandage (TPE), eisengrau RAL 7011 (Shore A 80)
- Kunststoff-Radkörper silbergrau RAL 7001 ohne Fadenschutz
- Gleitlager
- >>Kontaktverfärbung auf unversiegelten Böden möglich!<<

Radserie 29Kr

- thermoplastische Elastomer-Bandage (TPE) eisengrau RAL 7011 (Shore A 80)
- Kunststoff-Radkörper und Kunststoff-Fadenschutz silbergrau RAL 7001
- Präzisionskugellager
- >>Kontaktverfärbung auf unversiegelten Böden möglich!<<

Radserie 29Ka

- thermoplastische Elastomer-Bandage (TPE) eisengrau RAL 7011 (Shore A 80)
- elektrisch leitfähig
- Kunststoff-Radkörper und Kunststoff-Fadenschutz silbergrau RAL 7001
- Präzisionskugellager
- >>Kontaktverfärbung auf unversiegelten Böden möglich!<<

Wheel series 29Gr

- thermoplastic elastomer tyre (TPE) iron grey RAL 7011 (Shore A 80)
- plastic wheel centre silver grey RAL7001
- without thread guard
- plain bearing
- >>Contact discoloration on unsealed grounds possible!<<

Wheel series 29Kr

- thermoplastic elastomer tyre (TPE) iron grey RAL 7011 (Shore A 80)
- plastic wheel centre and thread guard silver grey RAL7001
- precision ball bearing
- >>Contact discoloration on unsealed grounds possible!<<

Wheel series 29Ka

- thermoplastic elastomer tyre (TPE) iron grey RAL 7011 (Shore A 80)
- electrically conductive
- plastic wheel centre and thread guard silver grey RAL7001
- precision ball bearing
- >>Contact discoloration on unsealed grounds possible!<<

29 Räder / Wheels
36 Räder / Wheels

Michelrollen
Furniture castors
Apparaterollen
Apparatus castors
Medizinisch-Technische Rollen
Medical equipment castors
Transportgeräterollen
Transport appliance castors
Edelstahlrollen
Stainless steel castors
Schwerlastrollen
Heavy duty castors
Bäckerrollen
Bakery castors
Räder
Wheels
Zubehör
Accessories



29K080v-1	80	30	36,5	8	80	
29K100v-1	100	30	36,5	8	100	
29K125v-1	125	32	36,5	8	100	
29K150v-1	150	32	36,5	8	120	
29K200v	200	32	36,5	8	120	
29K080y	80	30	36,5	8	80	
29K100y	100	30	36,5	8	100	
29K125y	125	32	36,5	8	100	
29K150y	150	32	36,5	8	120	
29K200y	200	32	36,5	8	120	
36K125b	125	33	36,5	8	100	

Radserie 29Kv

- thermoplastische Polyurethan-Bandage (TPU) eisengrau RAL 7011 (Shore A 95)
- kontaktverfärbungsfrei
- Kunststoff-Radkörper und Kunststoff-Fadenschutz silbergrau RAL 7001
- Präzisionskugellager

Radserie 29Ky

- thermoplastische Polyurethan-Bandage (TPU) eisengrau RAL 7011 (Shore A 95)
- elektrisch-leitfähig, kontaktverfärbungsfrei
- Kunststoff-Radkörper und Kunststoff-Fadenschutz silbergrau RAL 7001
- Präzisionskugellager

Radserie 36Kb

- Vollgummireifen eisengrau RAL 7011 (Shore A 80)
- Kunststoff-Radkörper
- und Kunststoff-Fadenschutz silbergrau RAL 7001
- Präzisionskugellager

Wheel series 29Kv

- thermoplastic polyurethane tyre (TPU) iron grey RAL 7011 (Shore A 95)
- free of contact discoloration
- plastic wheel centre and thread guard silver grey RAL7001
- precision ball bearing

Wheel series 29Ky

- thermoplastic polyurethane tyre (TPU) iron grey RAL 7011 (Shore A 95)
- electrically conductive, free of contact discoloration
- plastic wheel centre and thread guard silver grey RAL7001
- precision ball bearing

Wheel series 36Kb

- solid rubber tyre iron-grey RAL 7011 (Shore A 80)
- plastic wheel centre and plastic thread guard silver grey RAL 7001
- precision ball bearing

1C Räder / Wheels

1G Räder / Wheels



21C KFAD	50	18	22	6	40	
31C KFAD	75	25	28	6	60	
31C-32 KFAD NB36	80	32	36	8	80	
41C-25 KFAD NB30	100	25	30	6	80	
41C KFAD	100	32	36	8	80	
51C KFAD	125	32	36	8	100	
61C KFAD	150	32	36	8	120	



21G	50	18	21,5	8	40	
31G-8 NB26,5	75	25	26,5	8	60	
31G-30-12 NB36	80	32	35,5	12	80	
41G-25-8	100	25	35,5	8	80	
41G-35-12	100	32	35,5	12	80	
51G-35-12	125	32	35,5	12	100	
61G-35-12	150	32	35,5	12	120	

Radserie 1C

- Gabel aus hochfestem schlagzähem Nylon (RAL 7035)
- Lenkgabelkopf mit abgedichtetem Rillenkugellager
- auch als elektrisch-leitfähige oder rostfreie Variante verfügbar

Radserie 1G

- Polypropylen-Radkörper (RAL 7035) mit thermoplastischer Bandage (TPE, Shore A 87, RAL 7012)
- Fadenschutz (RAL 7035)
- Gleitlager

Wheel series 1C

- fork made of high-strength impact-resistant nylon (RAL 7035)
- swivel fork head with sealed deep groove ball bearing
- also available as electrically conductive and stainless steel variants

Wheel series 1G

- polypropylen wheel center (RAL 7035) with thermoplastic tyre (TPE, Shore A 87, RAL 7012)
- thread guard (RAL 7035)
- plain bearing

30 Räder / Wheels

Möbelrollen
Furniture castors
Apparaterollen
Apparatus castors
Medizinisch-Technische Rollen
Medical equipment castors
Transportgeräterollen
Transport appliance castors
Edelstahlrollen
Stainless steel castors
Schwerlastrollen
Heavy duty castors
Bäckerrollen
Bakery castors
**Räder
Wheels**
Zubehör
Accessories



30C075bZ	75	23	28	8	50	
30C100bZ	100	25	30	8	65	



30C075aZ	75	23	28	8	50	
30C100aZ	100	25	30	8	65	

Radserie 30Cb

- Vollgummireifen blaugrau (Shore A 80)
- Stahlblechfelge und Metall-Fadenschutz verzinkt-passiviert
- Flanschlager

Wheel series 30Cb

- solid rubber tyre blue-grey (Shore A 80)
- sheet steel metal rim
- thread guard zinc passivated
- flange bearing

Radserie 30Ca

- Vollgummireifen schwarz (Shore A 80)
- elektrisch-leitfähig
- kontaktverfärbungsfrei
- Stahlblechfelge und Metall-Fadenschutz verzinkt-passiviert
- Flanschlager

Wheel series 30Ca

- solid rubber tyre black (Shore A 80)
- elektrisch leitfähig
- free of contact discoloration
- metal thread guard
- sheet steel metal rim zinc passivated
- flange bearing

32 Räder / Wheels



32C080bZ	80	30	37	8	80	
32C100bZ	100	32	37	8	80	
32C125bZ	125	32	37	8	100	
32C150bZ	150	32	37	8	110	
32C200bZ	200	32	37	8	120	



32C080aZ	80	30	37	8	80	
32C100aZ	100	32	37	8	80	
32C125aZ	125	32	37	8	100	
32C150aZ	150	32	37	8	110	
32C200aZ	200	32	37	8	120	



32C100wZ	100	32	37	8	80	
32C125wZ	125	32	37	8	100	
32C150wZ	150	32	37	8	110	
32C200wZ	200	32	37	8	120	

Radserie 32Cb

- Vollgummireifen blaugrau (Shore A 80)
- Stahlblechfelge und Metall-Fadenschutz verzinkt-passiviert
- Flanschlager

Radserie 32Ca

- Vollgummireifen schwarz (Shore A 80)
- elektrisch-leitfähig
- kontaktverfärbungsfrei
- Stahlblechfelge und Metall-Fadenschutz verzinkt-passiviert
- Flanschlager

Radserie 32Cw

- 2-Komponenten-Reifen blaugrau
- Lauffläche Shore A 60, Reifenkern Shore A 85
- Stahlblechfelge und Metall-Fadenschutz verzinkt-passiviert
- Flanschlager

Wheel series 32Cb

- solid rubber tyre blue-grey (Shore A 80)
- sheet steel metal rim zinc passivated
- metal thread guard
- flange bearing

Wheel series 32Ca

- solid rubber tyre black (Shore A 80)
- electrically conductive
- free of contact discoloration
- metal thread guard
- sheet steel metal rim zinc passivated
- flange bearing

Wheel series 32Cw

- 2-components-tyre blue-grey
- tread Shore A 60, tyre core Shore A 85
- sheet steel metal rim and thread guard zinc-passivated
- flange bearing

33 Räder / Wheels

Möbelrollen
Furniture castors
Apparaterollen
Apparatus castors
Medizinisch-Technische Rollen
Medical equipment castors
Transportgeräterollen
Transport appliance castors
Edelstahlrollen
Stainless steel castors
Schwerlastrollen
Heavy duty castors
Bäckerrollen
Bakery castors
**Räder
Wheels**
Zubehör
Accessories



33C050aZ	50	18	22,5	6	40	
33C050bZ	50	18	22,5	6	40	
33C075bZ-08	75	23	28	8	50	
33C075pZ-08	75	23	28	8	50	
33G050b-06	50	18	21,5	6	40	
33G050b-08	50	18	21,5	8	40	
33G075b-08	75	23	27,5	8	50	
33G075b-10	75	23	27,5	10	50	
33G100b-08	100	23	29,5	8	65	
33G100b-12	100	23	29,5	12	65	

Radserie 33Ca

- Vollgummireifen elektrisch-leitfähig schwarz (Shore A 80)
- kontaktverfärbungsfrei
- Flanschlager

Radserie 33Cb

- Vollgummireifen blaugrau (Shore A 80)
- Kunststoff-Radkörper grau
- Metall-Fadenschutz verzinkt-passiviert (ab Ø 75 mm)
- Flanschlager

Radserie 33Cp

- Vollgummireifen blaugrau mit Profil (Shore A 80)
- Kunststoff-Radkörper grau
- Metall-Fadenschutz verzinkt-passiviert
- Flanschlager

Radserie 33Gb

- Vollgummireifen blaugrau (Shore A 80)
- Kunststoff-Radkörper schwarz
- Gleitlager

Wheel series 33Ca

- solid rubber tyre black (Shore A 80)
- electrically conductive
- free of contact discoloration
- flange bearing

Wheel series 33Cb

- solid rubber tyre blue-grey (Shore A 80)
- plastic wheel centre grey
- metal thread guard zinc-passivated (from Ø 75 mm)
- flange bearing

Wheel series 33Cp

- solid rubber tyre blue-grey with profile (Shore A 80)
- plastic wheel centre grey
- metal thread guard zinc-passivated
- flange bearing

Wheel series 33Gb

- solid rubber tyre blue-grey (Shore A 80)
- plastic wheel centre grey
- plain bearing

34 Räder / Wheels



34C050vZ	50	18	22,9	6	40	
34C050vZ-7021	50	18	22,9	6	40	
34C075vE	75	24	28	8	50	
34C075r	75	24	28	8	50	

Radserie 34Cv

- Polyurethan-Bandage eisengrau RAL 7011 (Shore A 95)
- Kunststoff-Radkörper und Kunststoff-Fadenschutz silbergrau RAL 7001
- Kugellager

Radserie 34Cv-7021

- Polyurethan-Bandage schwarz RAL 7021 (Shore A 95)
- Kunststoff-Radkörper schwarz
- Kugellager

Radserie 34CvE

- Polyurethan-Bandage eisengrau RAL 7011 (Shore A 95)
- Kunststoff-Radkörper und Kunststoff-Fadenschutz silbergrau RAL 7001
- Kugellager rostfrei

Radserie 34Cr

- thermoplastische Elastomer-Bandage (TPE) eisengrau RAL 7011 (Shore A 80)
- Kunststoff-Radkörper und Kunststoff-Fadenschutz silbergrau RAL 7001
- Kugellager
- >>Kontaktverfärbung auf unversiegelten Böden möglich!<<

Wheel series 34Cv

- polyurethane tyre iron grey RAL 7011 (Shore A 95)
- plastic wheel centre and plastic thread guard silver grey RAL 7001
- ball bearing

Wheel series 34Cv-7021

- polyurethane tyre black RAL 7021 (Shore A 95)
- plastic wheel centre black
- ball bearing

Wheel series 34CvE

- polyurethane tyre iron grey RAL 7011 (Shore A 95)
- plastic wheel centre and plastic thread guard silver grey RAL 7001
- corrosive resistant ball bearing

Wheel series 34Cr

- thermoplastic elastomer tyre (TPE) iron grey RAL 7011 (Shore A 80)
- plastic wheel centre and thread guard silver grey RAL7001
- ball bearing
- >>Contact discoloration on unsealed grounds possible!<<

18 Räder / Wheels

Möbelrollen
Furniture castors
Apparaterollen
Apparatus castors
Medizinisch-Technische Rollen
Medical equipment castors
Transportgeräterollen
Transport appliance castors
Edelstahlrollen
Stainless steel castors
Schwerlastrollen
Heavy duty castors
Bäckerrollen
Bakery castors
Zubehör
Accessories



18K085v-85-17	85	85	85	17	700	

18K100v-40-15	100	40	40	15	275	
18K125v-40-15	125	40	40	15	350	
18K150v-50-20	150	50	50	20	800	
18K150v-60-25	150	50	60	25	800	
18K200v-50-20	200	50	50	20	950	
18K200v-60-25	200	50	60	25	1000	
18K200v-80-30	200	80	80	30	1500	
18K250v-60-20	250	50	60	20	1150	
18K250v-60-25	250	50	60	25	1150	
18K250v-80-30	250	80	80	30	1800	
18K300v-80-30	300	80	80	30	2200	

Radserie 18Kv

- Polyurethan-Bandage rotorange (Shore A 95)
- Guss-Radkörper
- Präzisionskugellager

Wheel series 18Kv

- Polyurethane tyre red-orange (Shore A 95)
- bonded on cast wheel centre
- precision ball bearing

01 Räder / Wheels

27 Räder / Wheels



01R100sL	100	40	48	15	350	•
01R125sL	125	45	58	20	450	•
01R150sL	150	45	58	20	640	•
01R200sL	200	50	58	20	850	•
27R200IZ	200	50	60	20	75	

• Artikel auf Anfrage / product on request

Radserie 01Rs

- Grauguss silbergrau lackiert
- Rollenlager

Radserie 27RI

- Luftbereifung
- Stahlblechfelge
- Rillenprofil
- Rollenlager

Wheel series 01Rs

- grey casting tyre silver grey painted
- roller bearing

Wheel series 27RI

- pneumatic tyre
- sheet steel metal rim
- deep-groove profile
- roller bearing

Zubehör Accessories

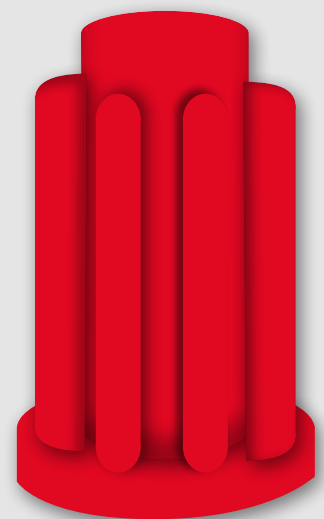

Befestigungen Attachments

für Artikel 340/341

Befestigungen R M10 (siehe Abbildung 1)
montiert oder separat lieferbar

for items 340/341

Attachments R M10 (see on picture 1)
delivered assembled or separately

für Artikel 357

Befestigungen R M10 (siehe Abbildung 2)
montiert oder separat lieferbar

for items 357

Attachments R M10 (see on picture 2)
delivered assembled or separately

für Artikel 367

Befestigungen R M12 (siehe Abbildung 2)
montiert oder separat lieferbar

for items 367

Attachments R M12 (see on picture 2)
delivered assembled or separately

für Artikel 340/341

Polyamidhülsen für Einschlagbefestigung »K0«
(siehe Abbildung 3) wird separat geliefert

for items 340/341

Polyamide sockets for locking attachment »K0«
(see on picture 3) delivered separately

für Artikel 357/367/600

Übersteckhülsen für Zapfen (siehe Abbildung 4)
wird separat geliefert

for items 357/367/600

Snap-on adaptors for fixing stems (see on picture 4)
delivered separately



Art.-Nr. für Rundrohre Art.-No. for round tubes	Rohrinnen-Ø mm Tube inside-Ø mm	Art.-Nr. für Vierkantrohre Art.-No. for square tubes	Rohrinnen-∅ mm Tube inside-∅ mm
R10	13,9–14,8	R22	16,6–18,7
R11	14,9–15,8	R23	18,8–19,5
R12	15,9–16,8	R24	19,6–21,5
R13	16,9–17,8	R25	21,6–22,5
R14	17,9–18,8	R26	22,6–24,5
R15	18,9–19,8	R27	24,6–26,5
R16	19,9–21,8	R28	26,6–28,5
R17	21,9–22,8	R29	28,6–33,0
R18	22,9–23,8		
R19	23,9–25,8		
R20	25,9–28,8		
R21	28,9–32,0		



Art.-Nr. für Rundrohre Art.-No. for round tubes	Rohrinnen-Ø mm Tube inside-Ø mm	Art.-Nr. für Vierkantrohre Art.-No. for square tubes	Rohrinnen-Ø mm Tube inside-Ø mm
R66	17,8–19,7	R72	21,0–21,9
R67	19,8–21,7	R73	22,0–24,0
R68	21,8–24,7	R75	25,8–28,5
R69	24,8–28,7	R76	28,6–29,5
R70	28,8–32,7	R77	29,6–32,7
		R79	34,6–37,0



Art.-Nr. Art.-No.	Rohrinnen-Ø mm Tube inside-Ø mm			Art.-Nr. Art.-No.	Rohrinnen-Ø mm Tube inside-Ø mm		
für Rundrohre for round tubes	Ø Hülsen Socket	Ø Bund Collar	mm Länge Lenght	für Vierkantrohre for square tubes	Ø Hülsen Socket	Ø Bund Collar	mm Länge Lenght
K14	14	18	36	K16x16	16x16	19x19	36
K16	16	18	36	K17x17	17x17	19x19	36
K17	17	19	36	K18x18	18x18	20x20	36
K18	18	20	36	K21x21	21x21	23,5x23,5	36
K19	19	21	36	K22x22	22x22	24,5x24,5	36
K20	20	22	36	K23x23	23x23	25,5x25,5	36
K22	22	24	36	K27x27	27x27	30x30	36
K23	23	25	36	für Holzkonstruktionen for wooden structures			
				K14-H	14	29	36



Art.-Nr. Art.-No.	Innen-Ø mm Inside-Ø mm	Außen-Ø mm Outside-Ø mm	Länge mm Lenght mm
H 24–27,0	24	27	45 (für Rundrohr) (for round tubes)
H 24–27,8	24	27,8	45 (für Rundrohr) (for round tubes)
H 24–28,0	24	28	45 (für Rundrohr) (for round tubes)
H 24–28,2	24	28,2	45 (für Rundrohr) (for round tubes)
H 24–28,4	24	28,4	45 (für Rundrohr) (for round tubes)
H 24–28,9	24	28,9	45 (für Rundrohr) (for round tubes)
H 24–33,65x33,65	24	33,6	45 (für Vierkantrohr) (for square tubes)

Lenksperren

Directional lock (screw-on)

ASLaZ

für Serie 441

- anschraubbare Lenksperre
- ab Raddurchmesser 150/160 mm
- verzinkt-passiviert

for series 441

- screw-on directional lock
- starting from wheel diameter 150/160 mm
- zinc passivated

ASL 478

für Serie 478

- anschraubbare Lenksperre
- verzinkt-passiviert

for series 478

- screw-on directional lock
- zinc passivated

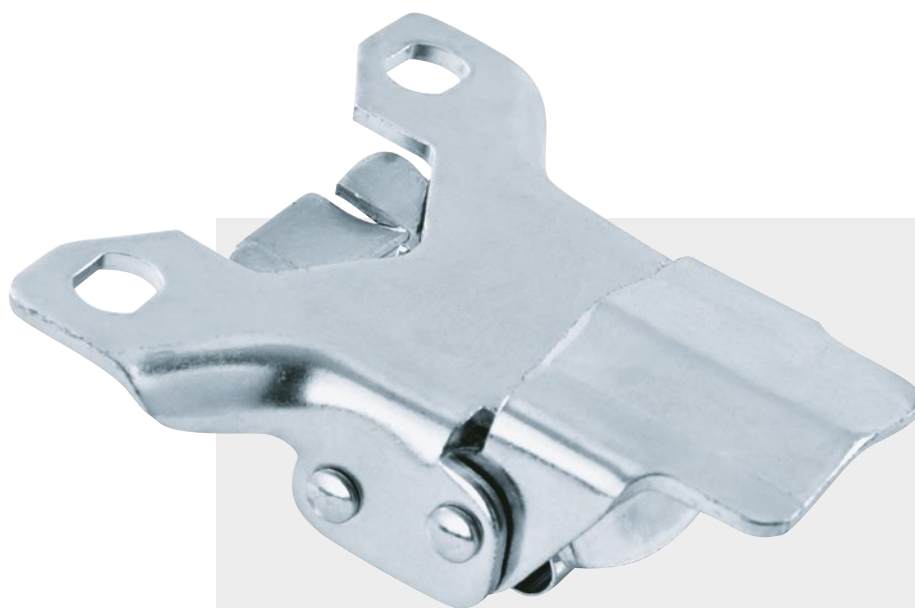

**separat zu
bestellen**
please order
separately!

**Sie haben spezielle
Anforderungen?**

Sprechen Sie uns an.

**Wir entwickeln gemeinsam
mit Ihnen eine Lösung.**

You have special requests?

Contact us.

**We develop a solution
together with you.**



Rollentechnik und Anforderungen

Castor technology and requirements

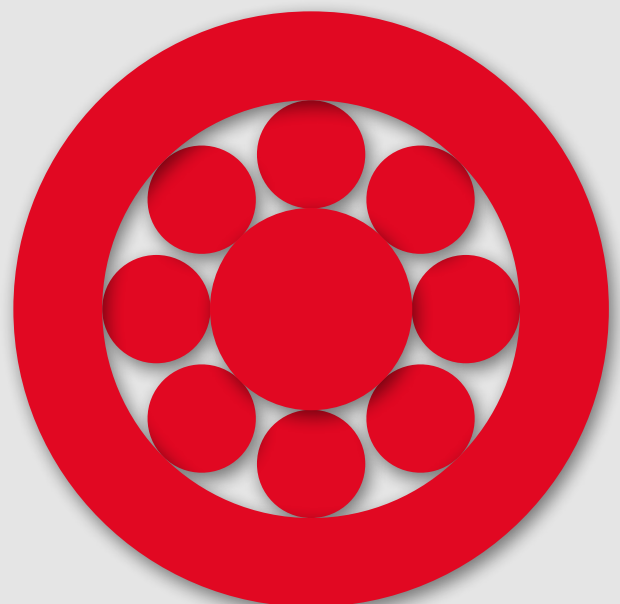

Rollentypen

Castor types

Bei den Rollen ist es wie bei uns Menschen – es gibt ganz unterschiedliche Typen und Charaktere.

Wir unterscheiden zwei Typen von Rollen:

With castors it is just like with people – there are various types and characteristics.

We distinguish between two types of castors:



Lenkrollen

Lenkrollen sind um eine vertikale Achse schwenkbar. Dadurch können Maschinen und Geräte manövriert werden. Um das Schwenken der Gabel zu ermöglichen, ist bei diesem Rollentyp die Lenkgabel über ein Schwenklager mit dem am Gerät fest montierten Befestigungselement verbunden. Das Schwenken der Gabel wird erleichtert, indem das Rad mit einem horizontalen Abstand zwischen den Achsen des Schwenklagers und des Rades befestigt ist. Diese sogenannte Ausladung unterstützt zudem die Stabilität des Laufverhaltens bei der Fahrt in eine Richtung. Lenkrollen werden mit oder ohne Feststeller gefertigt. Bei Lenkrollen mit Feststellrichtung können z. B. Rad, Gabelkopf und Richtung blockiert werden. Feststeller dürfen nur im Stillstand betätigt werden. Bewährte Befestigungselemente bei Lenkrollen sind Anschraubplatten, Stahleinsteckzapfen für Rohre und die Befestigung mittels Schraube über ein Rückenloch.



Swivel castors

Swivel castors can swivel on a vertical axis. In this way machines and equipment can be manoeuvred. In order to make it possible for the steering fork to swivel, in this type of castor, the steering fork is connected by means of a swivel bearing with the fixing element mounted in a fixed position on the apparatus. The swivelling of the fork and so the manoeuvrability of the equipment is made easier by having the wheels contact with the floor offset horizontally from the axis of the swivel bearing. Furthermore, this so-called off-set improves the stability of the rolling behaviour when moving in a straight line. Swivel castors are manufactured with or without brakes. Braked swivel castors enable, various modes such as wheel rotation, fork head rotation and direction, to be locked individually or collectively. Tested and proven fixing elements for swivel castors such as bolt-on plates, steel and plastic expanders for tube are available, and their attachment is made by means of screwing the required fixing into a blind tapped hole on the castor fork.



Bockrollen

Bockrollen sind nicht schwenkbar. Sie geben Geräten und Maschinen daher eine hohe Richtungsstabilität. Zur Befestigung werden meist die Anschraubplatten verwendet.



Fixed castors

Fixed castors cannot swivel. They give equipment and machines a high degree of directional stability. With regard to the fixings, bolt on plates are usually used.

Lenkrollen Swivel castors

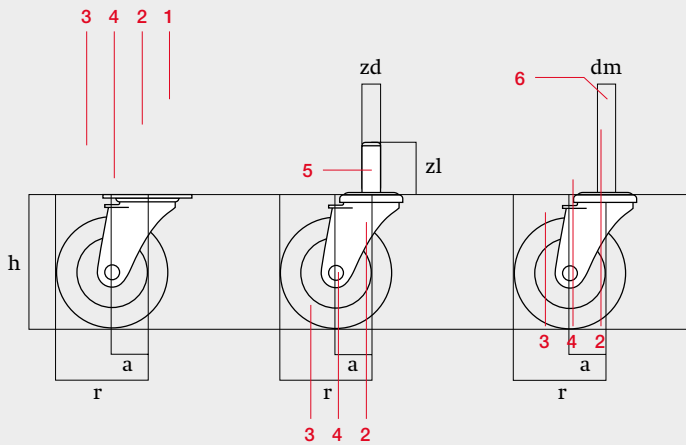

Bockrollen Fixed castors

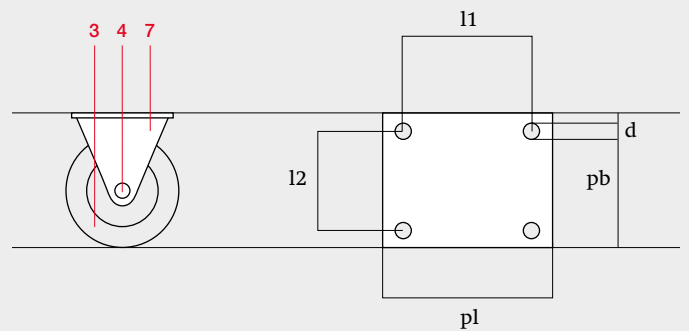

Bildlegende Rolle picture legend castor

1	Anschraubplatte plate	a	Ausladung offset	r	Schwenkradius (= Ausladung + 1/2Rad-Ø) turning radius (= swivel radius 1/2 wheel-Ø)
2	Lenkgabel swivel fork	d	Schraublochdurchmesser hole Ø	zd	Zapfendurchmesser diameter of pivot
3	Rad wheel	dm	Rückenlochdurchmesser bolt hole Ø	zl	Zapfenlänge pivot length
4	Radachse wheel-axle	h	Gesamthöhe/Bauhöhe total height		
5	Stahleinsteckzapfen steel stem	l1/l2	Schraublochentfernung hole distance		
6	Rückenloch bolt hole	pl	Plattenlänge plate length		
7	Bockgabel fixed fork	pb	Plattenbreite plate width		

Die richtige Radauswahl treffen. Make the right wheel selection.

Räder bringen Rollen erst zum Rollen. Sie bestehen aus verschiedenen Werkstoffen und haben ganz unterschiedliche Ausstattungsmerkmale. Die Beschaffenheit des Laufbelages und die verschiedenen Felgen- bzw. Radkörperarten sowie diverse Radlagerungen verleihen dem Rad vielfältige Eigenschaften. Räder haben somit unterschiedliche Tragfähigkeiten, Rollwiderstände und Laufqualitäten.

Die Auswahl der Radtypen ist abhängig von der Anwendung bzw. den Anforderungen des Rollensystems. Ein wichtiger Faktor ist die Belastbarkeit. Harte Radwerkstoffe sind im Allgemeinen höher belastbar als weiche. Sie haben jedoch den Nachteil, dass sie Stoßbelastungen, die z. B. bei unebenen Böden auftreten, unge-dämpft an das Gerät weitergeben. Ein anderes wichtiges Kriterium ist die Bodenbeschaffenheit. Sie ist entscheidend für das eingesetzte Reifen-/Radmaterial. Weiterhin sind hier die Umgebungseinflüsse zu berücksichtigen.

It's wheels that make castors roll. They are manufactured from various materials and have extremely varied design characteristics. The composition of the tyre and the various types of wheel rims or hubs as well as various wheel bearings give the wheel many different properties. Because of this wheels have differing load capacities, resistance to rolling and operational qualities.

The selection of wheel types is dependent on the application or the requirements of the castor system. One important factor is the ability to withstand load stress. As a rule hard wheel materials can withstand a heavier load than soft ones. They have the disadvantage, however, that they transmit thrust stresses to the equipment, when running on uneven ground, if no shock absorption is provided. Another important criteria in the choice of wheel is the condition of the ground surface. This decides the tyre and wheel materials used. Furthermore, environmental influences must also be taken into consideration.

Rad- und Reifen
Wheels and tyres

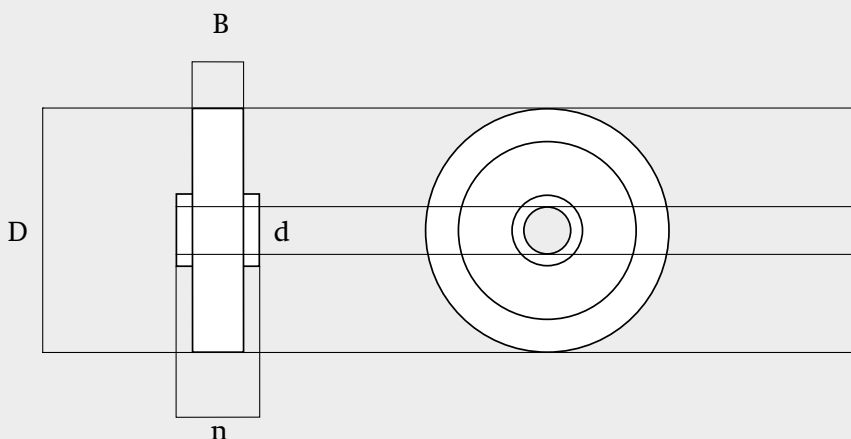

Bildlegende Rad
Dimensions

- D Raddurchmesser**
Wheel diameter
- B Laufflächenbreite**
Tread width
- d Achslochdurchmesser**
Axle diameter
- n Nabenlänge**
Hub length

Nachfolgend verschiedene Rad- und Reifentypen:

Harte Lauffläche

Polyamid/Polypropylen

- hohe Tragfähigkeit
- bruchstark und wartungsfrei
- weitgehend beständig gegen Salze, Fette, Säuren und Laugen

Guss

- hohe Tragfähigkeit
- abriebfest
- unempfindlich gegen Metallspäne und aggressive Stoffe

Elastische Lauffläche

Vollgummi/thermoplastischer Gummi

- geräuschloser Lauf
- bodenschonend

Elastik-Vollgummi

- hohe Belastbarkeit
- extrem abriebfest
- ausgezeichneter Fahr- und Bedienungskomfort

Polyurethan

- hohe Belastbarkeit
- robust und abriebfest
- elastischer, geräuscharmer Lauf
- weitgehend beständig gegen Öle, Fette, Benzin sowie eine Vielzahl von Chemikalien

Luft

- gute Stoßdämpfung
- geringer Rollwiderstand bei Einsatz auf schlechten Böden

Below are the most common types of wheels and tyres:

Hard tread

Polyamide/Polypropylene

- high load capacity
- unbreakable and maintenance-free
- largely resistant to salts, grease, acids and alkaline solutions

Cast metal

- high load capacity
- resistant to rubbing
- not sensitive to metal shavings and abrasive material

Elastic tread

Solid rubber/thermoplastic rubber

- silent operation
- easy on floors

Elastic solid rubber

- high load capacity
- extreme resisting to rubbing
- excellent running and serving comfort

Polyurethane

- high load capacity
- robust and resistant to rubbing
- elastic, quiet operation
- largely resistant to oils, grease, petrol, and a large number of chemicals

Pneumatic

- good shock absorbing characteristics
- low resistance to rolling when used on difficult ground

Radlagerarten

Bearing Types

Die Bauart des Radlagers ist von großer Bedeutung für die Laufeigenschaften einer Rolle und damit für die Beweglichkeit des Gerätes. Radlager müssen vielfältigsten Anforderungen entsprechen, wie z. B. Tragfähigkeit, Dauer des Einsatzes, Umgebungseinflüsse, Anfahr- und Rollwiderstand, Witterungsbeständigkeit usw.

Wir unterscheiden zwischen folgenden Radlagern:

The type of construction of the wheel bearing is of great significance for the operating properties of a castor and therefore for the mobility of the equipment. Wheel bearings must meet the most varied requirements, such as load bearing capacity, duration of use, environmental influences, resistance to impact shock, resistance to rolling, and resistance to weather, etc.

We distinguish between the following wheel bearings:

Gleitlager / Plain bearing

Das Gleitlager weist gute Laufeigenschaften auf. Als Lagermaterial hat sich bei Rädern Kunststoff durchgesetzt. Gleitlager werden insbesondere bei Transportgeräten, die nur wenig gefahren werden, verwendet. Unter normalen Bedingungen sind Gleitlager wartungsfrei, stoßunempfindlich und korrosionsbeständig.

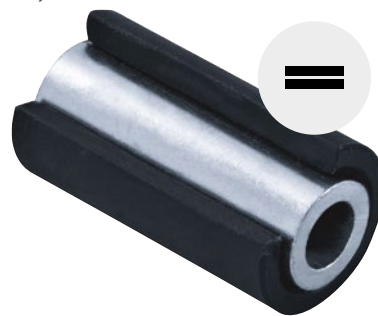

A solid bearing consists of a bearing shell solidly connected with the wheel. It demonstrates positive characteristics. The wheel turns around the axle tube bolted to the housing. Wheels made of polyamides have gained general acceptance for castors. Solid bearings are used traditionally for transport equipment that will not be moved much. Under normal conditions solid bearings are maintenance-free and corrosion-resistant.



Rollenlager / Roller bearing

Das Rollenlager besteht aus Stahl- bzw. Edelstahlwalzen, die in einem Käfig gelagert sind. Diese Walzen rollen zwischen dem Achsrohr und der Radnabe ab. Da bei der Drehung um die Achse keine Gleit-, sondern eine Rollreibung auftritt, ist der Rollwiderstand des Lagers selbst bei hoher Belastung relativ gering. Das Rollenlager hat sich insbesondere bei Transportgerätenrollen als Normalausführung durchgesetzt. Rollenlager sind widerstandsfähig, robust und weitgehend wartungsfrei.

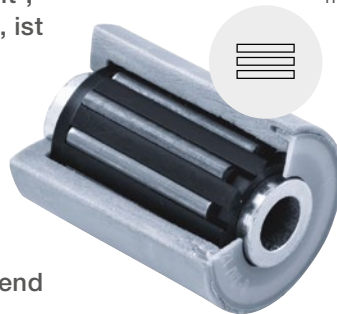

The roller bearing consists of steel or stainless steel rollers that are positioned in a cage. These rollers roll between the axle tube and the wheel hub. Since in turning around the axle no sliding friction but rather rolling friction occurs, the resistance to rolling of the bearing is relatively low even at high loads. The roller bearing has become generally accepted as the standard solution particularly for transport equipment castors. Roller bearings are resistant, robust and, to some degree, maintenance-free.

Kugellager / ball bearing

Das Rillenkugellager, auch Präzisionskugellager genannt, besteht aus Kugeln, die zwischen je einem gehärteten Innen- und Außenring laufen. Auch bei extremen Belastungen und höheren Geschwindigkeiten weist dieses Lager sehr gute Laufeigenschaften auf. Es erfüllt höchste Ansprüche an Tragfähigkeit, Beständigkeit gegen Umgebungseinflüsse und Leichtlauf. Durch abgedichtete Lager kann die Lebensdauerschmierung auch unter extremen Umgebungsbedingungen garantiert werden. Das einreihige Rillenkugellager ist der Standard im Bereich der technisch anspruchsvollen Rollen.

The deep-groove ball bearing, also called precision ball bearing, consists of balls that run between a tempered inside and an outside ring. Even under extreme loads and at high speeds this bearing demonstrates very good operating properties. It meets the most stringent demands for load bearing capacity, resistance to environmental influences and easy running. Due to sealed bearings life-long lubrication can be guaranteed even under extreme environmental conditions. The single-row deepgroove ball bearing is the standard for the area of technically demanding equipment and heavy load castors.

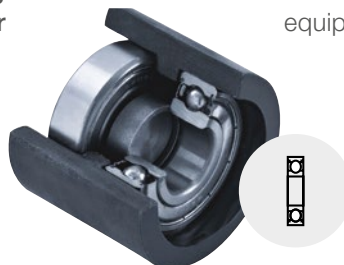

Zentralkugellager
central ball bearing

2 Kugellager
2 ball bearings

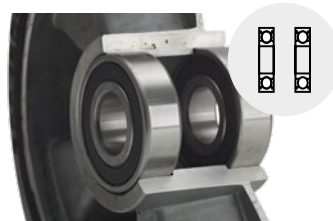

Gehäusevarianten

Types of housings

Schwenkeigenschaften einer Rolle werden nicht nur durch die Ausladung und den Raddurchmesser, sondern auch durch die Konstruktion des Schwenklagers bestimmt. Im Folgenden sind verschiedene Schwenklagerarten beschrieben, die sich als Standardbauarten in verschiedenen Einsatzbereichen bewährt haben.

Die Rollengehäuse werden aus Stahlblech, in Stahlschweiß-Konstruktion oder aus Kunststoff gefertigt. Die Qualität und Güte der verwendeten Materialien erfüllen höchste Ansprüche.

The swivelling properties of a castor are determined not only by the size and the wheel, but also by the construction of the swivel bearing. Below various types of swivel bearings are described that have been generally accepted as standard types of construction in the most varied fields of application.

The castor housings are manufactured from sheet steel, as a welded fabrication or from plastic. The quality of the metal to be processed fulfills the most demanding requirements.

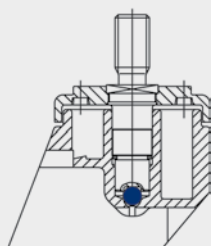

Schwenklager mit Gleitlagerstift

Diese Bauart wird im Möbel-, Apparaterollen- und Medizinisch-Technischen-Bereich für geringe und mittelschwere Belastungen eingesetzt. Sie ist weitgehend gegen Wasser, Staub und Schmutz geschützt.

Swivel bearing with solid bearing axle

This type of construction is used in the furniture and equipment castor sector for light and medium-heavy loads. It is protected to a great extent against water, dust and dirt.

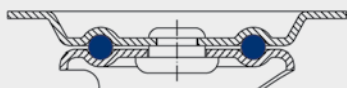

Schwenklager mit einreihigem Kugellauf

Eine einfache Lagerart für den Apparate- und Transportgerätebereich. Durch die Art der Prägung des Kugellaufes wird eine gute Lenkbarkeit bei normalen Einsatzbedingungen erreicht.

Swivel bearing with single race ball

The illustration on the side shows a simple type of bearing for the equipment and transport sector. Through careful design of the ball track, good steerability under normal usage conditions is achieved.



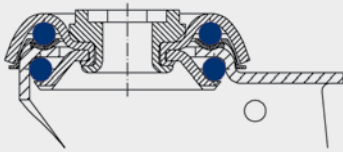

Schwenklager mit zweireihigem Kugellauf

Diese Bauart wurde für den mittleren und schweren Apparate- und Transportgerätenbereich entwickelt. Die sehr kompakte Bauform hält starken statischen und dynamischen Beanspruchungen gut stand. Weitere Merkmale sind ausgezeichnete Lenkbarkeit, spielarme Führung sowie ein verbesserter Schutz gegenüber dem einreihigen Schwenklager. Ein Dichtring bewirkt zusätzlichen Schutz gegen Schmutz und Spritzwasser.

Swivel bearing with double ball race

The type of construction seen in the illustration was developed for the medium and heavy equipment castor sector. The very compact construction shape stands up to stringent static and dynamic demands. Further characteristics are excellent steerability with little play, as well as better protection in comparison with the single-row swivel bearing. A sealing ring provides additional protection against dirt and water spray.

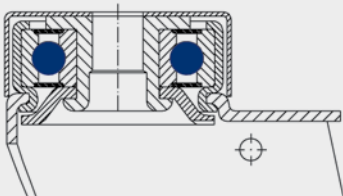

Schwenklager mit Präzisionskugellager

Das Schwenklager besteht aus einem Präzisionskugellager. Spielfreiheit, Leichtgängigkeit und weitgehende Verschleißfestigkeit in mittleren und hohen Tragfähigkeitsbereichen kennzeichnen diese Lagerart. Sie ist darüber hinaus weitgehend gegen Staub, Wasser und Schmutz geschützt.

Swivel bearing with precision ball bearing

Swivel bearings consist of a precision deep-groove ball bearing. Little free play, smooth running and extensive wear resistance. In addition it is protected to a great extent against water, dust and dirt. This bearing is used for castor applications of medium and high load capacities.

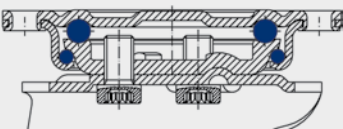

Schwenklager mit geschlossenem Speziallenkkopf

Das Schwenklager mit zweireihigem Kugellauf ist für den Einsatz im höheren Transportgeräte- und im unteren Schwerlastbereich geeignet. Der geschlossene Speziallenkkopf mit Dauerfettfüllung ist gegen Staub und Spritzwasser geschützt. Die Ausführung ist durch Verschraubung mit der Gabel sehr stoßbelastbar.

Swivel bearing with closed special head

This double-row ball bearing is for use in the lower load bearing of higher transport devices. The completely closed steering head with permanent self-lubrication is protected against dust and water spray. The solution is extremely well suited to withstand the horizontal side forces associated with this type of castor usage.

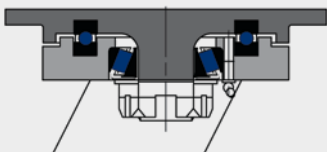

Schwenklager mit Axialkugel- und Kegelrollenlager

Diese Schwenklagerart besteht aus einem Axial-Rillenkugellager und einem Kegelrollenlager. Beide Lager sind abgedichtet und können nachgeschmiert werden. Besondere Kennzeichen sind hervorragende Funktionssicherheit, Leichtgängigkeit und Schmutzempfindlichkeit. Diese Lagerart eignet sich besonders für sehr hohe Belastungen.

Swivel bearing with axle bearing and tapered roller bearing

This swivel bearing represents the highest degree of performance. It consists of two tapered roller bearings opposite each other. Both bearings are sealed and additional lubrication can be added. Its special characteristics are outstanding functional safety, smooth running and a lack of dirt ingress. This type of bearing is especially appropriate for very high loads.

Feststellervarianten

Types of brakes

Die Feststeller der Rolle haben die Aufgabe, das Gerät oder die Maschine sicher im Stillstand zu halten. Daher sind sie eine wichtige Komponente in Bezug auf die Sicherheit.

Sechs Typen von Feststellern stehen zur Auswahl:

The brake mechanism of the castor has the task of holding the equipment or the machine firmly in the stop position. Therefore they are important components in relation to safety.

Six types of brake mechanisms are available for selection:



1. Radfeststeller Typ b

Feststeller blockiert die Drehung des Rades.

1. Wheel locking brake Type b

Brake locks the wheel from rotating.



2. Totalfeststeller nachlaufend Typ h

Feststeller für Apparate-, Transport- und Medizinisch-Technische Rollen. Er blockiert Rad und Gabelkopf gleichzeitig, nachlaufend montiert.

2. Total brake mounted behind Type h

Brake for apparatus and transport castors mounted behind locks the wheel and the fork head at the same time.



3. Totalfeststeller vorlaufend Typ i

Feststeller für Transport-, Schwerlastrollen und Rollen für den Entsorgungsbereich. Er blockiert Rad und Gabelkopf gleichzeitig, vorlaufend montiert.

3. Total brake mounted in front Type i

Brake for transport and heavy load bearing castors locks the wheel and fork head at the same time, mounted in front.



4. Zentralfeststeller Typ q

Feststeller für Medizinisch-Technische Rollen. Feststellvorrichtung in einer Rolle integriert, blockiert Rad und Gabelkopf gleichzeitig.

4. Central brake Type q

Brake for medical-technical castors. Braking device integrated into the castor body; locks the wheel and fork head at the same time.



5. Richtungsfeststeller Typ r

Feststeller für Apparate- und Medizinisch-Technische Rollen mit integrierter Richtungsfeststellung, fixiert die Lenkrolle im Geradeauslauf.

5. Directional brake Type r

Brake for equipment and hospital beds with integrated directional locking brake, locks the steerable castor in the straightahead position.



6. Lenksperre Typ ASL anschraubbar

Nachträglich anschraubbarer Richtungsfeststeller, fixiert die Lenkrolle im Geradeauslauf bei Transportgeräterollen (siehe Kapitel »Zubehör«).

6. Directional lock Type ASL (bolt on)

Directional locking brake that can be retro fitted, locks the steerable castor in the straightahead position for transport castors (see chapter »Accessories«).

Befestigungen

Attachments

Zwischen der Rolle und dem Transportgerät muss eine feste Verbindung hergestellt werden. Die Art sowie die entsprechende Dimensionierung des Verbindungselementes richtet sich nach der Konstruktion und nach dem Einsatzbereich des Transportgerätes. Dabei können erheblich unterschiedliche Kräfte auf die Rollenbefestigung wirken.

For good practice a firm connection must be made between the castor and the transport device. The type and the size of the fixing element must suit the construction and the field of application of the transport device. Here considerably different forces can affect the castor attachment.



L Rückenloch

Durchgangsloch durch die Schwenkachse der Rolle für die Verbindung mit dem fahrbaren Gerät.

L Bolt hole

Access hole through the swivelling axis of the castor for connection with movable equipment.



G Gewindestift

Zum Anschrauben an Metall- oder Holzkonstruktionen.

G Threaded stem

For screwing into metal or wood structures.



R Sprezhülsen-Befestigung für Rohre

(siehe Kapitel »Zubehör«)

R Expanding socket fitting for tubes

(see chapter »Accessories«)



P Platte

Zum Anschrauben z. B. an Metall- oder Holzkonstruktionen.

P Plate

For bolting onto metal or wooden structures.



K0 Stift für Polyamid-Hülsen

Für Rund- und Vierkant-Rohre sowie Holzkonstruktionen (siehe Kapitel »Zubehör«).

K0 Stem for nylon sockets

For \emptyset - and tubes as well as wood structures (see chapter »Accessories«).



Z Stahlzapfen

Zur stabilen Befestigung in Rohren.

Z Fixing stem

For stable attachment in tubes.

CS Flachzapfen

Auf Anfrage lieferbar.

CS flat stem

On inquiry available.

Übersteckhülsen

Für Zapfen und K0-Stift (siehe Kapitel »Zubehör«).

Sockets

For fixing stems (see chapter »Accessories«).

Manövrierbarkeit

Manoeuvrability

Die Lenkbarkeit von Geräten und Maschinen ist abhängig von der Position der einzelnen Rollen. Verschiedene Möglichkeiten der Anordnung zeigen, in welche Richtung es gehen kann:

The steerability of equipment and machines is dependent upon the position of the individual castors on the equipment. Various arrangement possibilities show what direction it can go:

Vier Lenkrollen gleicher Bauhöhe.

Die optimale Anordnung, um in engen Gängen nach allen Richtungen hin beweglich zu sein. Bei der Geradeausfahrt lässt sich das Gerät jedoch schlechter steuern. Durch den Anbau eines Richtungsfeststellers an mindestens einer Lenkrolle kann dieses Verhalten optimiert werden.

Four swivel castors at the same height on the structure.

This is the optimum arrangement in order to be mobile in all directions. However in narrow corridors when moving straight ahead, this configuration makes the equipment more difficult to steer. By installing a directional lock on at least one swivel castor this behaviour can be optimised.

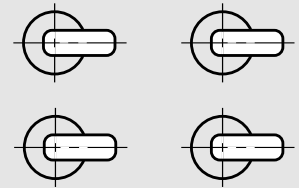

Je zwei Lenkrollen und Bockrollen gleicher Bauhöhe.

Die wohl meist eingesetzte Rollenanzahl, die für unterschiedlichste Richtungen geeignet ist. Für eine gute Geradeausfahrt ebenso wie bei der Kurvenfahrt. Anstelle der Bockrollen kann alternativ auch ein Radsatz, d. h. zwei Räder auf einer Achse eingesetzt werden. Problematisch erweist sich die Anordnung jedoch in engen Gängen.

Two swivel castors and two fixed castors at the same height on the structure.

Probably the most-often used arrangement for castors that is suitable for the most varied applications ie for moving straight ahead correctly as well as for curved trajectories. As an alternative there is a possibility to install a wheelset, or two wheels on an axis, instead of a fixed castor. This arrangement proves to be problematic in narrow passages.

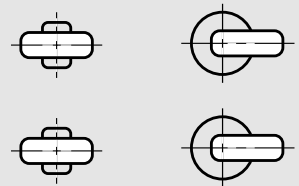

Chemische Beständigkeit

Chemical resistance

Äußere Einwirkungen können dem Transportsystem, insbesondere den Rädern, zusetzen. Im Wesentlichen unterscheiden wir zwei Arten von Belastungen:

- 1. Bestimmungsgemäßer Kontakt zu chemischen Substanzen.**
- 2. Umgebungseinflüsse, die in flüssiger oder gasförmiger Form am Einsatzort vorherrschen.**

Beide Formen der Belastung können bei Rollen und ihren einzelnen Komponenten Auswirkungen in Form von Korrosion, Oberflächenveränderungen, Festigkeitsverlusten, Versprödungen und Schmierstoffspuren haben. Rollen, die in problematischen Umgebungen eingesetzt werden, sind auf ihre Bestandteile hin wie z. B. Gehäuse, Radkörper und Reifen zu prüfen. Die Kontaktdauer, Konzentration der angreifenden Substanzen, aber auch Luftfeuchtigkeit und Temperatur sind Faktoren, die die chemische Beständigkeit beeinflussen. Die Angaben in der rechts stehenden Tabelle dienen Ihnen zur Orientierung. Alle aufgeführten Werte gelten nicht für Chemikaliengemische.

Entsprechende Details sind im Technikratgeber auf www.colson-rollen.com zu finden.

External effects can damage the transport system, especially the wheels. Basically we distinguish between two types of adverse chemical influences:

- 1. Contact with chemical substances in accordance with the regulations.**
- 2. Environmental influences of fluid or gas that prevail at the place of use.**

Both these influences can adversely effect not only the overall performance of the castor or wheel, but also the individual components of the assembly, in the form of corrosion, surface changes, loss of strength, embrittlement and degradation of the lubricant properties. Castors that will be used in such problematic environments must have the suitability of their components such as housing, wheel hub, and tyres checked. Not only time in contact, the concentration of the aggressive chemical substances, but also the humidity and the temperature are factors that influence chemical resistance. The information in the following tables can be used as a guide. The values given are not valid for chemical mixtures.

More details can be found in the castor guidebook at www.colson-castors.de.

Anfahr- und Rollwiderstände beurteilen

Assessing resistance to starting and rolling

Bodenbeschaffenheit, Gesamtgewicht des Gerätes, Art der Bereifung und Bauart des Lagers wirken auf den Anfahr- und Rollwiderstand und haben somit Einfluss auf die Manövrierbarkeit des Gerätes.

Ground conditions, total weight of the device, type of tyres and type of bearing affect the resistance to starting up and running, and therefore have an influence on the manoeuvrability of the device.

Bodenverhältnisse

In Bezug auf die Bodenverhältnisse gilt: harter Boden – weiches Rad und umgekehrt. Das Rollen in Wohn-, Büro oder Betriebsräumen erfordert unterschiedliche Produktprofile. So sollten z. B. im Wohn- und Bürobereich keine Eindrücke auf Teppichböden hinterlassen werden. Neben bodenschonender Qualität sind Anforderungen an die Materialbeständigkeit gegenüber Chemikalien, Ölen, Temperaturen, Alterung und Lagerung zu berücksichtigen.

Ground conditions

In relation to ground conditions the following general rule applies: hard ground – soft wheel and vice versa. The type of floor surface requires the choice of a different product profile. For example, in living and office areas no impression should be left behind on fitted carpets or marks left on shiny polished floors. In addition to qualities that are kind to floor surfaces, requirements for material resistance to chemicals, oils, ageing and storing should also be taken into account.

Flächenpressung

Bodenbeläge insbesondere in Türbereichen werden durch Rollen stark belastet. Die max. Flächenpressung ist daher ein wichtiger Faktor bei der Kombination Rolle/Bodenbelag (Einheit: N/mm²). Sie sollte immer unter der zulässigen Flächenpressung des Bodenbelages liegen, damit dieser geschont wird. Je größer die Rollentraglast, desto breiter und größer die Räder. Weiche Radmaterialien und große Radbreiten reduzieren die max. Flächenpressung, erschweren jedoch die Manövrierbarkeit des Transportsystems.

Surface pressure

Floor covering, especially in the high traffic areas around doors, is heavily affected by being rolled over by a wheel. The maximum surface pressure is therefore an important factor in the combination of castor and floor covering (unit: N/mm²). It should always be below the permitted surface pressure of the floor covering, so that it is protected. For good practice the greater the load on the castors, the wider and larger the wheel should be. Soft wheel material reduces the maximum surface pressure, however they make the manoeuvrability of the transport system more difficult.

Kontaktverfärbung

Spuren zu hinterlassen muss nicht immer ratsam sein. Vor allem wenn ein schwarzes Gummirad nach längerem Stand helle Bodenbeläge dunkel einfärbt. Dies nennt man Kontaktverfärbung. Um diese Nebenwirkung zu vermeiden, werden hochwertige und elektrisch leitfähige Gummiräder kontaktverfärbungsfrei geliefert. Aggressive Reinigungsmittel oder unversiegelte Böden können jedoch die Kontaktverfärbungsfreiheit negativ beeinflussen. Wir beraten Sie gerne!

Contact discoloration

Leaving behind traces is not always advisable. This is most apparent when a black rubber tyre is left standing on a light floor covering for a long time. This is called contact discoloration. In order to avoid this side effect, high quality and electrically conductive rubber tyres are manufactured free of contact discoloration. Aggressive cleaning agents or unsealed grounds can influence the contact discoloration freedom negatively. If you need further information, please let us know!

Kreidung

Kreidung nennt man die Verfärbung des Bodens durch Partikel des Reifens. Dies ist ein physikalischer Prozess, der bei elastischen Bereifungen auftritt und kaum zu vermeiden ist. Kreidung kann mit handelsüblichen Reinigungsmitteln, z. B. für PVC-, Gummi- und Steinbeläge entfernt werden.

Anfahr-, Roll- bzw. Schwenkwiderstand

Räder rollen nicht von selbst. Sie müssen bewegt werden. Der Anfahrwiderstand muss überwunden werden, um ein in Ruhe befindliches Gerät in Bewegung zu setzen. Die Kraft, die aufgewendet werden muss, um ein Gerät in Bewegung zu halten bzw. zu lenken, nennt man Roll- oder auch Schwenkwiderstand. Dieser Widerstand ist von verschiedenen Faktoren abhängig, wie z. B. der Belastung, dem Raddurchmesser, dem Rad- bzw. Bandagenmaterial, der Lagerart, der Ausladung der Rolle und der Bodenbeschaffenheit. Weitere Kriterien, die den Schwenkwiderstand beeinflussen, sind z. B. unterschiedliche Schwenklagerarten, Kugellauf- und Kugeldurchmesser.

Chalking

The coloration of the floor by particles of the tyre is called chalking. This is a physical process that occurs with elastic tyres and is very difficult to avoid. However chalking can be removed with standard cleaning products, on surfaces such as PVC, rubber and stone.

Resistance to starting, rolling and swivelling

Wheels do not roll by themselves. They have to be moved. The force that has to be applied in order to move a device forward, or to steer, is called rolling or swivelling resistance. This resistance is dependent upon various factors, such as the load, the diameter of the wheel, the tyre material, the type of bearings, the offset radius of the castor, and the ground conditions. Criteria that also influences the resistance to swivelling are types of swivel bearings, ball track and ball bearing diameter.

Tragfähigkeit

Load rating

Die Tragfähigkeit zählt neben den Bodenverhältnissen zu den wichtigsten Auswahlkriterien für Räder und Rollen. Um die jeweils erforderliche Tragfähigkeit bestimmen zu können, müssen folgende Variablen bekannt sein:

1. **Eigengewicht des Transportgerätes**
2. **maximale Zuladung**
3. **Anzahl der eingesetzten Räder und Rollen**

Die genaue Berechnung der erforderlichen Tragfähigkeit:

$$T = \frac{E+Z}{n-1}$$

- T erforderliche Tragfähigkeit von Rad bzw. Rolle
E Eigengewicht des Transportgerätes
Z maximale Zuladung
n Anzahl der eingesetzten Räder bzw. Rollen

Load rating is considered, in addition to ground conditions, amongst the most important selection criteria for wheels and castors. In order to be able to determine the load rating required in each case, the following must be known:

1. **The weight of the transport device**
2. **Maximum additional load**
3. **Number of wheels or castors used**

To calculate the exact load rating:

$$T = \frac{E+Z}{n-1}$$

- T required load rating of wheel or castor
E weight of the transport device
Z Maximum additional load
n Number of wheels or castors used

Umgebungsverhältnisse

Environmental conditions

Rollen müssen sich nicht nur in geschlossenen Räumen behaupten – ihre Qualität sollte auch äußeren Einflüssen trotzen. Rollen, die das ganze Jahr im Freien eingesetzt werden, sind äußeren Einflüssen wie z.B. Witterung und Temperaturen ausgesetzt. Eine Kombination aus Temperatur und Feuchtigkeit kann sich besonders problematisch auswirken.

Colson baut vor – durch Oberflächenveredelungen der Stahlblechkomponenten. Die Teile werden z. B. verzinkt-passiviert, verchromt oder pulverbeschichtet. Bei Einsätzen in besonders rauen Umgebungen empfehlen wir rostfreie Rollen, z. B. aus Edelstahl.

Die Temperaturbeständigkeit ist individuell zu bewerten. Sie ist von den verschiedensten Faktoren abhängig. Zunächst unterscheiden wir zwischen Hoch- und Tieftemperaturbeständigkeit. Die optimale Auswahl der Rollen wird ferner geprägt von Einflussfaktoren wie z. B. Einwirkungsdauer der Temperatur, Belastung, diverse Umwelteinflüsse und Bodenbeschaffenheit.

Zusätzlich zu den Umgebungseinflüssen nimmt auch die Reinigung von Rollen einen wachsenden Stellenwert ein. Für die Reinigung, z. B. in Autoklaven und mit Hochdruckreinigern, empfehlen wir korrosionsgeschützte Rollen aus rostfreiem Stahl, aus verchromtem Stahlblech und hochwertigen Kunststoffen.

Castors not only have to hold their ground in closed rooms – their quality should also defy outside influences. Castors that are used the whole year in the open air are subjected to external influences in relation to adverse weather and extreme temperatures. A combination of temperature and humidity can have a particularly bad effect.

Colson makes provisions for this – through surface improvements to the sheet steel components. The parts are for example galvanised, chrome-plated or powder coated. For use in particularly harsh environments we recommend rust-free castors, manufactured from stainless steel.

Temperature resistance must be assessed individually for each application. It is dependent upon many varied factors. In the selection process first we investigate the high and low temperature resistance. The final selection of castors is then shaped by influencing factors such as the duration of effect of the temperature, stresses, various environmental influences and ground conditions.

In addition to the environmental influences, the degree to which the castors are washable also has increasing importance. For cleaning in autoclaves or any with high pressure cleaning we recommend corrosion-protected castors, made of stainless steel, chrome-plated steel and high-quality plastics.

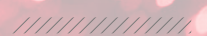

Benennung Designation	Typschlüssel Type Code	Werkstoff Material	kurzzeitig Short Term	bei Dauereinwirkung for continuous effects	Wasser und Wasserdampf bis ca. 40 °C Water and steam to approx. 40 °C	Wasser, Seifenlösungen bis ca. 50 °C Water, soap solutions to approx. 50 °C	Pflanzliche und tier. Fette Vegetable and animal fats	Seewasser, Streusalzlösungen Seawater, brine	Benzin, Diesel, Heizöl petrol, diesel, fuel oil	Schmieröle, Schmierfette Lubricating oils, and greases
Art der Bereitung/Bandage Type of tyre/band		Temperaturbeständigkeit in °C Temperature resistance °C		Chemische Beständigkeit Chemical resistance						
elektrisch-leitfähiger Reifen antistatic tyres	a	Vollgummi solid rubber	-40/+80	-10/+60	+	(+)	(+)	+	-	-
blaugrauer Vollgummireifen blue-grey tyres	b	Vollgummi solid rubber	-40/+80	-10/+60	+	(+)	(+)	+	-	-
schwarzer Vollgummireifen black tyres	c	Vollgummi solid rubber	-40/+80	-10/+60	+	(+)	(+)	+	-	-
Elastik-Vollgummireifen resilient tyres	e	Vollgummi (stahldraht- armiert) solid rubber (reinforced with steel wire)	-40/+80	-10/+60	+	(+)	(+)	+	-	-
hitzebeständig heat resistant tyres	h	spezielle Gummimischung special rubber mixture	-40/+250	-40/+180	+	+	+	+	-	-
Rillenprofil pneumatic tyres grooved tread	l	Gummi rubber	-40/+80	-10/+60	+	(+)	(+)	+	-	-
Polyamid Nylon	p + x	Polyamid Nylon	-30/+120	-30/+80	+	+	+	+	+	+
Polypropylen Polypropylene	z	Polypropylen Polypropylene	-30/+120	-30/+80	+	+	+	+	(+)	+
Thermoplastische Bandage TPE Thermoplastic-tyre (TPE)	r	TPE TPE	-40/+60	-30/+50	+	(+)	(+)	+	-	(+)
Guss grey cast-iron	s	Grauguß grey cast-iron	-40/+350	-40/+350	+	+	+	(+)	+	+
Polyurethan Polyurethane tyre	v + y	Polyurethan Polyurethane	-40/+120	-20/+80	+	(+)	+	+	+	+
2-Komponenten-Reifen 2-components-tyre	r + w	2 Komponenten 2 components	-40/+80	-10/+60	+	(+)	(+)	+	-	-

Legende Tabelle

- + beständig
- (+) bedingt beständig
- unbeständig

Diese Tabelle ist nicht rechtsverbindlich.

Table key

- + resistance
- (+) conditional resistance
- not resistant

This table is not mandatory.

Bestellsystem



Transparenz ist heute eine Grundvoraussetzung für Vertrauen. In diesem Sinne haben wir auch unser Bestellsystem konzipiert. Es basiert auf einer klaren und einfachen Systematisierung des meist komplexen Aufbaus einer Rolle. Sämtliche Produktspezifikationen spiegeln sich im Colson-Produktschlüssel wider. Auf diese Weise können Sie schnell und einfach die für Ihre individuellen Bedürfnisse optimale Rolle zusammenstellen. Grundsätzlich unterscheiden wir drei Kategorien, nach deren Unterpunkten alle Colson-Artikelnummern strukturiert sind: Am Ende der Bestellnummer befindet sich der Hinweis für die Befestigung. Bei farblich unterlegten Feldern können Sie aus unserer Auswahl an Befestigungsgrößen selbst wählen bzw. für Zapfen und Spreizhülsen selbst die gewünschte Größe angeben.

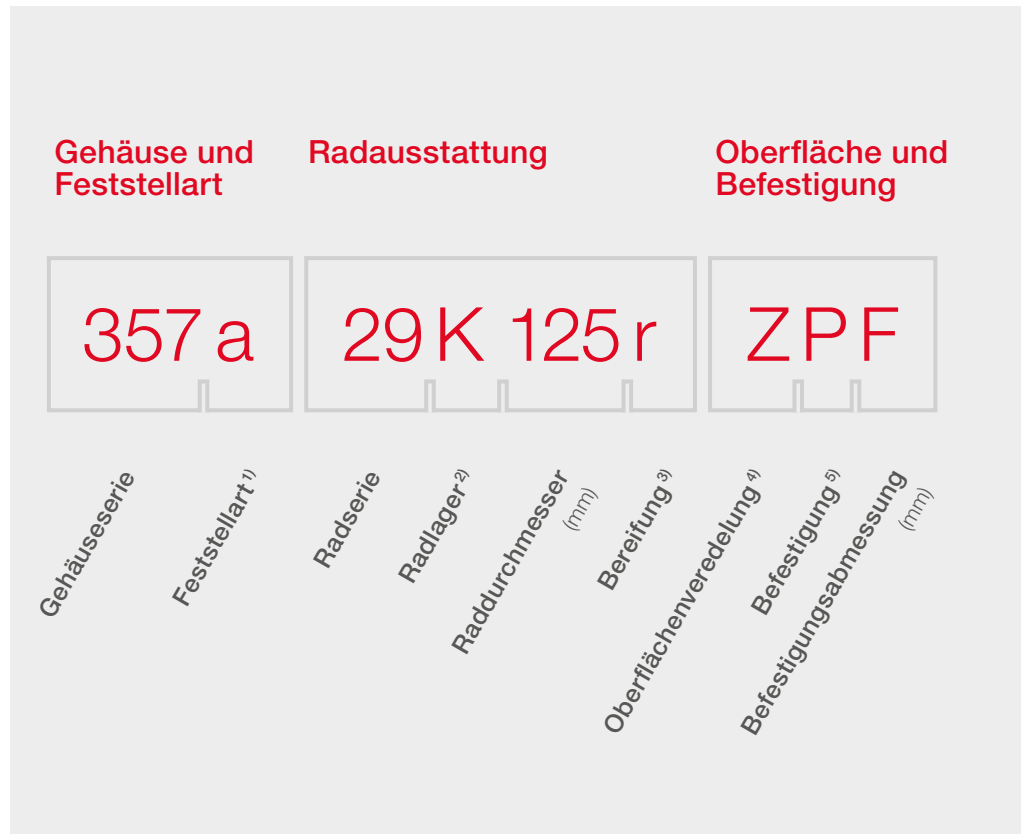

1) Feststellart

- a ohne Feststeller
- b Feststeller
blockiert Radlauf
- h Totalfeststeller
nachlaufend
- i Totalfeststeller
vorlaufend
- k Totalfeststeller
nachlaufend
- q Zentralfeststeller
- r Richtungsfeststeller

2) Radlager

- G Gleitlager
- C Flanschlager
- K Präzisionskugellager
- R Rollenlager

3) Bereifung

- a* elektrisch-leitfähiger Reifen (10^4 Ohm), Shore A 80
- b blaugrauer Vollgummireifen, Shore A 80;
Radserie 14, Shore A 64
- c schwarzer Vollgummireifen, Shore A 80
- d Elastik-Vollgummireifen blau, Shore A 70
- e Elastik-Vollgummireifen schwarz, Shore A 67, Shore A 70
- h hitzebeständiger Reifen
- l Rillenprofil (Luftreifen)
- n Rad aus Polypropylen weiß
- p Rad aus Polyamid weiß
- r thermoplastische Elastomer-Bandage (TPE) grau, Shore A 80
- s Gussrad
- v Polyurethan-Bandage, Shore A 95
- w 2-Komponenten-Reifen blaugrau, Lauffläche Shore A 60,
Reifenkern Shore A 85 (für höhere Tragfähigkeiten)
- x Rad aus Polyamid schwarz
- y* thermoplastische Polyurethan-Bandage (TPU),
elektrisch-leitfähig (10^4 Ohm), Shore A 95
- z Rad aus Polypropylen schwarz

4) Oberflächenveredelung

- C verchromt
- E Edelstahl
- G gelb-chromatiert
- K Kunststoff
- Z verzinkt-passiviert

5) Befestigung

- G Gewindestift
- L Rückenloch
- P Platte
- R Spreizhülsenbefestigung
für Rohre
- Z Zapfen
- KO Rohreinstechhülsenstift



*Kennzeichnung der elektrischen Leitfähigkeit eines Rades ist immer ein gelber Punkt auf der Bandage.

Platte



PB
54x54 mm
SE 40x40 mm

PC
60x60 mm
SE 47x47/37x37 mm

PD
77x67 mm
SE 61x51/50x42 mm

PF
95x70 mm
SE 75x45/72x52 mm

PG
104x84 mm
SE 72x52/80x60 mm

PH
104x80 mm
SE 72x52/80x60 mm

PI
115x85 mm
SE 80x55/60 mm

PK
138x109 mm
SE 105x75/80 mm

PS
Sonderabmessungen

Rückenloch



LC
Ø 10,2/11 mm

LD
Ø 12,2/13 mm

Gewindesttift



GC
M 10x25 mm

GD
M 12x25 mm

GI
M 12x15 mm

GU
1/2 – UNC13 x1

Spreizhülse



R
Weitere Angaben
siehe Kapitel
»Zubehör«

Zapfen



CS
(Flachzapfen)

522
Ø 24x45 mm/(M8/19)

622
Ø 28x45 mm/(M8/19)

Übersteckhülsen
siehe Kapitel
»Zubehör«

Rohreinsteckhülse



KO
Ø 11 mm
Länge 33,4 mm

Einsteckhülsen
siehe Kapitel
»Zubehör«

Bei allen Zapfen-
befestigungen
befindet sich die
Bohrung in
Fahrtrichtung!

Auf
Wunsch kann
die Bohrung auch
quer zur Fahrtrich-
tung ausgeführt
werden!



Article-Code-System



These days transparency is a basic prerequisite for trust. We have also designed our ordering system with this in mind. It is based on a clear and simple systematisation of the most complex structures of a castor. All the product specifications are reflected in the Colson product key. In this way you can compose the optimal castor for your individual needs quickly and simply. In principle we distinguish between three categories, according to whose sub-points Colson item numbers are structured: The reference for the fixing is located at the end of the order number. For fields with a coloured background you can choose your own fixing sizes from our selection, or for expanders or sockets you can specify the desired size yourself.

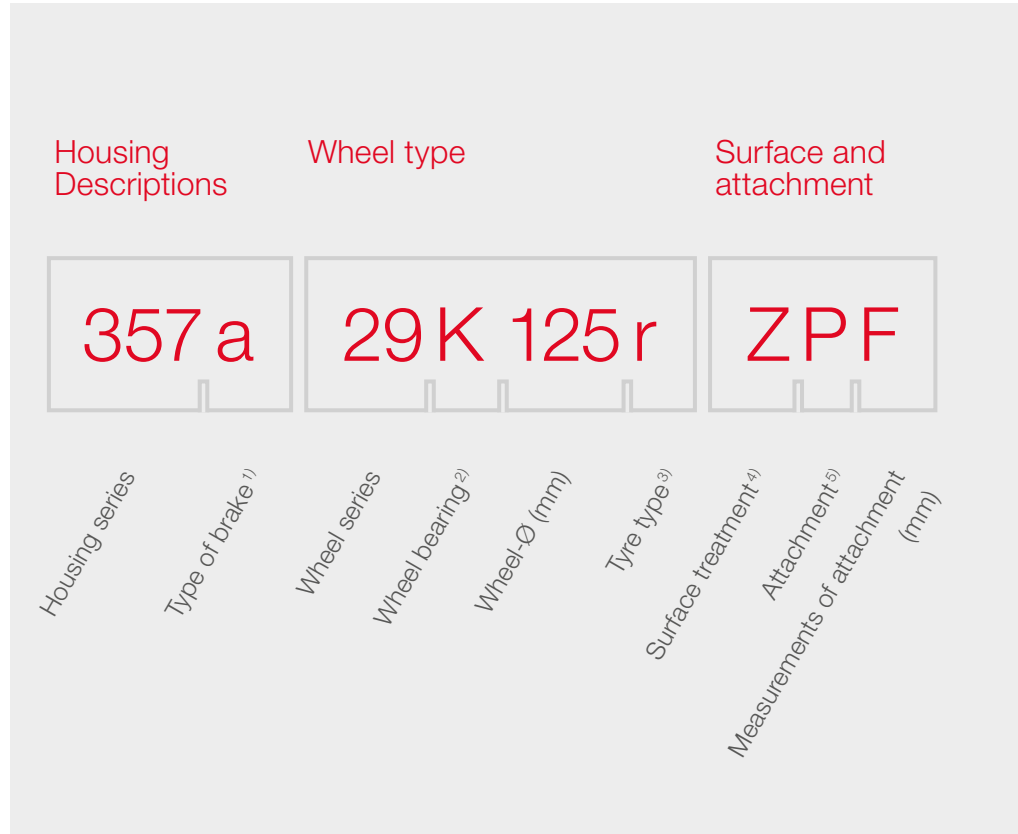

1) Type of brake

- a Without brake
- b Wheel locking brake
- h Total brake mounted behind
- i Total brake mounted in front
- k Total brake mounted behind
- q Central brake
- r Directional brake

2) Wheel bearings

- G Plain bearing
- C Flange bearing
- K Precision ball bearing
- R Roller bearing

3) Tyre Type

- a* Electrically conductive tyre (<10*Ohm), Shore A 80
- b Solid rubber tyre blue-grey, Shore A 80; wheel series 14 Shore A 64
- c Solid rubber tyre black, Shore A 80
- d Elastic solid rubber tyre blue, Shore A 70
- e Elastic solid rubber tyre black; wheel series 14 Shore A 67; wheel series 17 Shore A 70
- h Heat-resistant tyre
- l Deep groove profile tyre (pneumatic tyres)
- n Polypropylene tyre white
- p Polyamide tyre white
- r Wheel series 29/34 thermoplastic tyre (TPE) grey, Shore A 80
- s Cast tyre
- v Polyurethane tyre Shore A 95
- w 2-components-tyre blue-grey, operational surface Shore A 60, tyre core Shore A 85, for higher load capacities
- x Polyamide tyre black
- y* Thermoplastic polyurethane tyre (TPU), electrically conductive (<10*Ohm), Shore A 95
- z Polypropylene tyre black

4) Surface finishing

- C Chrome plated
- E Sheet steel
- G Yellow chrome plated
- K Solid plastic
- Z Zinc passivated

5) Attachment

- G Threaded stem
- L Bolt hole
- P Plate
- R Expanding socket
- Z Fixing stem
- KO Polyamide socket



*Marking of the electrically conductive tyre can be shown with a yellow dot on the outer diameter of the tyre.

Plate



PB
54x54 mm
SE 40x40 mm

PC
60x60 mm
SE 47x47/37x37 mm

PD
77x67 mm
SE 61x51/50x42 mm

PF
95x70 mm
SE 75x45/72x52 mm

PG
104x84 mm
SE 72x52/80x60 mm

PH
104x80 mm
SE 72x52/80x60 mm

PI
115x85 mm
SE 80x55/60 mm

PK
138x109 mm
SE 105x75/80 mm

PS
Sonderabmessungen

Bolt hole



LC
Ø 10,2/11 mm

LD
Ø 12,2/13 mm

Threaded stem



GC
M 10x25 mm

GD
M 12x25 mm

GI
M 12x15 mm

GU
1/2 – UNC13 x1

Expanding socket



R
Internal tube
measurement
see chapter
»Accessories«

Fixing stem



CS
(Flachzapfen)
522
Ø 24x45 mm/(M8/19)

622
Ø 28x45 mm/(M8/19)

Available sockets
see chapter
»Accessories«

Nylon socket stem



K0
Ø 11 mm
Länge 33,4 mm

Available sockets
see chapter
»Accessories«

Tapped hole
always in
travel direction.

On request
also available with
tapped hole across
to travel direction.



Produkthaftung/AGBs

Sehr geehrter Rollenkunde,

gemäß der im »Produkthaftungsgesetz« definierten Haftung des Herstellers für seine Produkte sind die nachfolgenden Informationen über Räder und Rollen zu beachten. Die Nichtbeachtung entbindet den Hersteller von seiner Haftungspflicht.

1.0 Produktinformation und bestimmungsgemäße Verwendung

Räder und Rollen im Sinne dieser Definition sind Bauteile, die im Allgemeinen austauschbar sind und an dafür vorgesehene Geräte, Möbel und Transportsysteme oder hierzu artverwandte Produkte zur Fahrbarmachung angebaut werden.

Diese Produktinformation bezieht sich auf Räder und Rollen, insbesondere auf passiv lenkende Rollen (Lenkrollen), für nicht maschinell bewegte Fahrzeuge und Geräte, im Folgenden Objekte genannt, die üblicherweise nicht schneller als mit Schrittgeschwindigkeit und nicht im Dauerbetrieb bewegt werden. Räder und Rollen im Sinne dieser Produktinformation können für folgende Anwendungsbereiche eingeteilt werden:

Wohnbereich

z. B. Sitzmöbel, Wohnmöbel

Dienstleistungsbereich (allg. Dienstleistungsbereich)

z. B. Einkaufswagen, Büromaschinen

Krankenhausbereich

z. B. Krankbetten

Industrieller Bereich mittlere und schwere Tragfähigkeit

z. B. Transportgeräte

Zur bestimmungsgemäßen Verwendung gehört insbesondere die fachgerechte Montage:

- Das Produkt muss an allen dafür vorgesehenen Punkten fest mit dem Objekt verbunden werden.
- Das Objekt muss an diesen Stellen ausreichende Festigkeit haben.
- Die Funktion des Produktes darf durch die Montage nicht beeinträchtigt oder verändert werden.
- Lenkrollen müssen so montiert werden, dass ihre Schwenkachsen senkrecht stehen.

- Bockrollen müssen so montiert werden, dass ihre Radachsen zueinander fluchten.
- An einem Objekt sind nur Lenkrollen gleicher Art zu verwenden. Werden auch Bockrollen angebaut, so dürfen nur die hierfür vom Hersteller empfohlenen Rollen montiert werden.

Für Feuchträume, bei direkter Bewitterung, in Meeresnähe oder für den Einsatz in aggressiver, korrosionsfördernder Umgebung müssen Produkte in Sonderausführung spezifiziert werden. Bei Verwendung im Temperaturbereich unter 5 °C und über 30 °C sind Produkte in Sonderausführung zu spezifizieren. Auf keinen Fall dürfen Standardprodukte unter diesen Bedingungen mit Nennlast betrieben werden.

Rad, Gehäuse, Feststelleinrichtung und Achszubehör bilden eine Funktionseinheit. Haftungspflicht besteht nur für unsere Originalprodukte. Bei der Auswahl der Rollen müssen alle möglichen Belastungen bekannt sein. Andernfalls sind diese mit ausreichenden Sicherheitszuschlägen abzuschätzen.

2.0 Fehlgebrauch

Ein Fehlgebrauch – d. h. die nicht bestimmungsgemäße Produktnutzung von Rädern und Rollen – liegt beispielsweise vor, wenn:

- die Räder und Rollen mit einer höheren Traglast zum Einsatz kommen als die max. Tragfähigkeit im Katalog ausweist,
- der Einsatz auf ungeeignetem, unversiegeltem, unebenem Boden erfolgt,
- zu hohe oder zu niedrige Umgebungstemperaturen vorliegen,
- ein Gerät mit festgestellten Rollen gewaltsam bewegt wird,
- besonders aggressive Medien einwirken können,
- unsachgemäß grobe Stoß- und Fallbelastungen zur Wirkung kommen,
- Fremdkörper in die Bandagen eindringen können,
- die Räder und Rollen mit einer zu hohen Geschwindigkeit eingesetzt werden,
- Veränderungen vorgenommen werden, die nicht mit dem Hersteller abgestimmt sind.

3.0 Produktleistung

Sofern die Produktleistung nicht in unseren Katalogen, Prospekten, Leistungsbeschreibungen etc. konkret festgelegt ist, müssen die Anforderungen an unsere Rollen bzw. deren Bauteile mit uns vereinbart werden. Richtungsweisend hierbei sind die einschlägigen DIN-, ISO- und CEN-Normen sowie die Güterrichtlinie RAL-RG 607/10.

4.0 Produktwartung

Räder und Rollen müssen je nach Erfordernis regelmäßig

- durch Nachfetten von Lagerstellen
- durch Nachstellen von lösbaren Verbindungen gewartet werden.

Es dürfen nur solche Reinigungsmittel verwendet werden, die keine korrosionsfördernden und schädigenden Bestandteile enthalten. Rollen bzw. deren Bauteile sind zu ersetzen, sobald Funktionsstörungen auftreten.

5.0 Informations- und Instruktionspflichten

Zur Erfüllung der Informations- und Instruktionspflichten sowie der Wartungsarbeiten nach dem Produkthaftungsgesetz stehen zur Verfügung:

- für den Handel/Weiterverarbeiter: Kataloge mit Produkt und Benutzerinformation
- für den Benutzer: Produkt- und Benutzerinformation.

Zur Sicherstellung der Funktion von Rädern und Rollen

- ist der Handel gehalten, diese Produktinformation (Punkt 1.0–5.0) und die Benutzerinformation zu beachten und bei Bedarf vom Hersteller anzufordern und an den Weiterverarbeiter auszuhändigen.
- sind Verarbeiter gehalten, diese Produktinformation (Punkt 1.0–5.0) zu beachten und bei Bedarf vom Hersteller oder Handel anzufordern und an den Benutzer weiterzugeben.

Überlastungssymbole

	der Tragfähigkeit
	durch Stoß und Fall
	durch unebene Böden
	durch Bewegungen im festgestellten Zustand
	durch Querkraft
	durch chemische Medien
	durch thermische Einwirkungen
	durch überhöhte Geschwindigkeit: max. 4 km/h

Gefahrensymbole



Unterlassungssymbol



Allgemeine Geschäftsbedingungen

Es gelten ausschließlich die allgemeinen Geschäftsbedingungen der Colson Rollen GmbH, deren Inhalt unter www.colson-rollen-raeder.de/agb.html zum Download zur Verfügung steht.

Der Inhalt dieses Kataloges wurde mit größter Sorgfalt erarbeitet. Etwaige Fehler und Farbabweichungen können nicht ausgeschlossen werden. Maße und Gewichte unterliegen branchenüblichen, fertigungstechnisch bedingten Abweichungen. Tragfähigkeitsangaben beziehen sich immer auf bestimmte, produkttypische Einsatzbedingungen. Änderungen, die dem Fortschritt dienen, behalten wir uns vor.

Product liability

General sales conditions

Dear Customer,

According to the definition of the liability of manufacturers for the products they produce, as given in the “law of Liability for Products”, the following information about wheels and castors applies. Deviation from this information, as written, releases the manufacturer of its liability.

1.0 Product Information and Determined Uses

Wheels and castors, according to this definition, are components that are generally replaceable. They are installed on equipment, furniture, material handling systems or similar products to make these products mobile. This product information refers to castors and wheels, particularly to swivel castors (not steered castors) which are used on nonpowered equipment; at a speed not to exceed the normal walking speed and not being used continuously. Castors and wheels, according to this product information, can be classified by application into the following categories:

Domestic Uses

i.e. seating, furniture

General

i.e. shopping carts, office equipment

Health care

i.e. beds, carts etc.

Industrial Uses

i.e. material handling of all load capacities

Castors and wheels can have a long and trouble free life if the following criteria are adhered to:

- correct and secure mounting at the designated location
- the mounting location must have adequate strength and material for a positive attachment
- the operation of the castor must not be affected by the attaching
- the swivel bearing king stem axis must be vertical at all times
- rigid castors must have their wheels axles perpendicular to the direction of travel. If only swivel castors are used they must be of similar types

- if rigid castors are used in conjunction with swivel castors, all castors must be compatible and in accordance with the specifications recommended by the manufacturer

For use in temperatures below 5 °C (40 °F) and above 30 °C (85 °F), the performance of the castor can be impaired, particularly the load capacity, as stated, can be affected when used in temperatures below or above these stated limits. Special components must be specified. Castors are made of component parts. The manufacturer is only liable for the original components incorporated in the assembled castor. When selecting a castor, it is necessary to take into consideration the technical details in the published charts for a castor.

2.0 Misuse

The word “misuse” is defined as:

- Overloading
- Unsuitable, unsealed floor conditions
- Excessive (high or low) temperatures
- Failure to use brakes properly
- Exposure to a caustic environment
- Excessive shock loading
- Foreign objects penetrating the wheel tread
- Excessive speed
- Changes made to components and to assembled castors without prior agreement and approval of the original manufacturer

3.0 Product Capability

Should the user not find the required product in the manufacturer's catalogues, leaflets, descriptive literature, etc. then any new castor designed for a particular application has to be fully approved by the manufacturer. New designs must be subject to the relevant DIN-, ISO-, CEN-Standards as well as the standard set forth in the Quality Standard RAL-RG 607/10.

4.0 Maintenance

The maintenance of castors is usually:

- Regreasing the axle and swivel bearings and removing any debris from these areas.
- Retightening the axle and/or any adjustable fittings.

If cleaning agents are used, these agents must not contain corrosive or granular elements.

5.0 Product-Information and User Guide

It is necessary to insure that the Product Information and User Guide are made available as required and that the reseller insures that his customer is furnished with the appropriate catalogues, etc.; that the Original Equipment Manufacturer, on whose equipment the product is attached, insures the end user colour differences cannot be guaranteed. Dimensions and weights are within the normal industry manufacturing standards. The indication of load capacities are always referring to certain conditions of use which are typical for this sort of product. All indications are subject to progressive changes. To insure proper performance of the castors and wheels, the reseller must consider the Product Information (1.0 to 5.0). This product information can be supplied for distribution to the manufacturer of the equipment. The manufacturer of the equipment must refer to the product Information (1.0 to 5.0) and User Guide. Copies of this Product Information and User Guide may be ordered from the castor manufacturer for distribution to the end user.

General conditions of sale and delivery

The terms and conditions of Colson Rollen GmbH (Germany) are valid in general and can be downloaded from the website www.colson-castors.de/terms-of-use.html.

Omission-Symbol

	of load capacity
	through shock or fall
	through uneven floor
	through moving when brake applied
	through lateral forces
	through chemical substances
	through temperature influences
	through excessive speed: max. 4 km/h

Danger-Symbol



Forbidden-Symbol



This catalogue has been carried out with attention and care. Possible mistakes and colour differences cannot be guaranteed. Dimensions and weights are within the normal industry manufacturing standards. The indication of load capacities are always referring to certain conditions of use which are typical for this sort of product. All indications are subject to progressive changes.



Colson Rollen GmbH

Industriestraße 8
Industriegebiet West 1
42499 Hückeswagen

Tel. +49 (0)2192 9368 0
Fax +49 (0)2192 9368 477

info@colson-rollen.com
www.colson-rollen.com

Impressum

V.i.S.d.P.: Ernst Jan Venema
Redaktion: Sandra Longobardi
Konzept/Gestaltung: margo.eu

Fotografie: Titel (v.o.l.n.u.r.): ©06photo–Fotolia, ©Kzenon–shutterstock,
©spotmatikphoto–Fotolia, ©lvdesign77–iStock, ©wavebreakmedia–shutterstock,
©industrieblick–Fotolia, ©fotoali–shutterstock, ©industrieblick–Fotolia;
S. 6, S. 91, S. 147: ©Denys Prykhodov–shutterstock;
S. 10: ©wavebreakmedia–shutterstock; S. 20: ©lvdesign77–iStock;
S. 70: ©spotmatikphoto–Fotolia; S. 98: ©fotoali–shutterstock;
S. 118: ©industrieblick–Fotolia; S. 122: ©industrieblick–Fotolia;
S. 160 (oben): ©Andy Nowack–Fotolia; S. 167: ©Jenov Jenovallen–Fotolia;
S. 170: ©Patrick Daxenbichler–Fotolia

© Copyright: Colson Rollen GmbH, November 2024

Nachdruck sowie Vervielfältigung, auch auszugsweise, sind ohne Genehmigung
von Colson Rollen nicht gestattet.

Editorial

V.i.S.d.P.: Ernst Jan Venema
Editor: Sandra Longobardi
Concept/Design: margo.eu

Photography: Title (f.t.l.t.b.r.): ©06photo–Fotolia, ©Kzenon–shutterstock,
©spotmatikphoto–Fotolia, ©lvdesign77–iStock, ©wavebreakmedia–shutterstock,
©industrieblick–Fotolia, ©fotoali–shutterstock, ©industrieblick–Fotolia;
p. 6, p. 91, p. 147: ©Denys Prykhodov–shutterstock;
p. 10: ©wavebreakmedia–shutterstock; p. 20: ©lvdesign77–iStock;
p. 70: ©spotmatikphoto–Fotolia; p. 98: ©fotoali–shutterstock;
p. 118: ©industrieblick–Fotolia; p. 122: ©industrieblick–Fotolia;
p. 160 (top): ©Andy Nowack–Fotolia; p. 167: ©Jenov Jenovallen–Fotolia;
p. 170: ©Patrick Daxenbichler–Fotolia

© Copyright: Colson Rollen GmbH, November 2024

The reprinting or copying of this catalogue - or parts thereof - is expressly
forbidden without prior permission from Colson.

